



Programmable Controller

**MELSEC iQ-F**  
series

MELSEC iQ-F  
FX5 User's Manual (MODBUS Communication)

---







# SAFETY PRECAUTIONS

---

(Read these precautions before use.)

Before using this product, please read this manual and the relevant manuals introduced in this manual carefully and pay attention to safety in order to handle the product correctly.

This manual classifies the safety precautions into two categories: [ WARNING] and [ CAUTION].

 <b>WARNING</b>	Indicates that incorrect handling may cause hazardous conditions, resulting in death or severe injury.
 <b>CAUTION</b>	Indicates that incorrect handling may cause hazardous conditions, resulting in minor or moderate injury or property damage.

Depending on the circumstances, procedures indicated by [ CAUTION] may also cause severe injury.

It is important to follow all precautions for personal safety.

Store this manual in a safe place so that it can be read whenever necessary. Always forward it to the end user.

## [DESIGN PRECAUTIONS]

---

### **WARNING**

- Make sure to set up the following safety circuits outside the PLC to ensure safe system operation even during external power supply problems or PLC failure. Otherwise, malfunctions may cause serious accidents.
  - Note that when the CPU module detects an error, such as a watchdog timer error, during self-diagnosis, all outputs are turned off. Also, when an error that cannot be detected by the CPU module occurs in an input/output control block, output control may be disabled. External circuits and mechanisms should be designed to ensure safe machine operation in such a case.
- Construct an interlock circuit in the program so that the whole system always operates on the safe side before executing the control (for data change) of the PLC in operation.  
Read the manual thoroughly and ensure complete safety before executing other controls (for program change, parameter change, forcible output and operation status change) of the PLC in operation. Otherwise, the machine may be damaged and accidents may occur due to erroneous operations.
- For the operating status of each station after a communication failure of the network, refer to relevant manuals for the network. Incorrect output or malfunction may result in an accident.

## [Security Precautions]

---

### **WARNING**

- To maintain the security (confidentiality, integrity, and availability) of the programmable controller and the system against unauthorized access, denial-of-service (DoS) attacks, computer viruses, and other cyberattacks from unreliable networks and devices via the network, take appropriate measures such as firewalls, virtual private networks (VPNs), and antivirus solutions.

## [WIRING PRECAUTIONS]

---

### **WARNING**

- Make sure to cut off all phases of the power supply externally before attempting installation or wiring work. Failure to do so may cause electric shock or damage to the product.
  - Make sure to attach the terminal cover, provided as an accessory, before turning on the power or initiating operation after installation or wiring work. Failure to do so may cause electric shock.
  - The temperature rating of the cable should be 80°C or more.
  - Make sure to properly wire to the terminal block (European type) in accordance with the following precautions. Failure to do so may cause electric shock, equipment failures, a short-circuit, wire breakage, malfunctions, or damage to the product.
    - The disposal size of the cable end should follow the dimensions described in the manual.
    - Tightening torque should follow the specifications in the manual.
    - Twist the ends of stranded wires and make sure that there are no loose wires.
    - Do not solder-plate the electric wire ends.
    - Do not connect more than the specified number of wires or electric wires of unspecified size.
    - Affix the electric wires so that neither the terminal block nor the connected parts are directly stressed.
- 

## [WIRING PRECAUTIONS]

---

### **CAUTION**

- Install module so that excessive force will not be applied to terminal blocks, power connectors, I/O connectors, communication connectors, or communication cables. Failure to do so may result in wire damage/breakage or PLC failure.
  - Make sure to observe the following precautions in order to prevent any damage to the machinery or accidents due to malfunction of the PLC caused by abnormal data written to the PLC due to the effects of noise.
    - (1) Do not bundle the power line, control line and communication cables together with or lay them close to the main circuit, high-voltage line, load line or power line. As a guideline, lay the power line, control line and communication cables at least 100 mm away from the main circuit, high-voltage line, load line or power line.
    - (2) Ground the shield of the shielded wire or shielded cable at one point on the PLC. However, do not use common grounding with heavy electrical systems.
- 

## [STARTUP AND MAINTENANCE PRECAUTIONS]

---

### **WARNING**

- Do not touch any terminal while the PLC's power is on. Doing so may cause electric shock or malfunctions.
  - Before cleaning or retightening terminals, cut off all phases of the power supply externally. Failure to do so in the power ON status may cause electric shock.
  - Before modifying the program in operation, forcible output, running or stopping the PLC, read through this manual carefully, and ensure complete safety. An operation error may damage the machinery or cause accidents.
  - Do not change the program in the PLC from two or more peripheral equipment devices at the same time. (i.e. from an engineering tool and a GOT) Doing so may cause destruction or malfunction of the PLC program.
-

## [STARTUP AND MAINTENANCE PRECAUTIONS]

---

### **CAUTION**

---

- Do not disassemble or modify the PLC. Doing so may cause fire, equipment failures, or malfunctions. For repair, contact your local Mitsubishi Electric representative.
  - Turn off the power to the PLC before connecting or disconnecting any extension cable. Failure to do so may cause equipment failures or malfunctions.
  - Turn off the power to the PLC before attaching or detaching the following devices. Failure to do so may cause equipment failures or malfunctions.
    - Peripheral devices, expansion board and expansion adapter
    - Extension modules, bus conversion module and connector conversion module
    - Battery
-

# INTRODUCTION

---

This manual contains text, diagrams and explanations which will guide the reader in the correct installation, safe use and operation of the FX5 MODBUS Communication and should be read and understood before attempting to install or use the unit.

It should be read and understood before attempting to install or use the unit. Store this manual in a safe place so that you can read it whenever necessary.

Always forward it to the end user.

## Regarding use of this product

- This product has been manufactured as a general-purpose part for general industries, and has not been designed or manufactured to be incorporated in a device or system used in purposes related to human life.
- Before using the product for special purposes such as nuclear power, electric power, aerospace, medicine or passenger movement vehicles, consult Mitsubishi Electric.
- This product has been manufactured under strict quality control. However when installing the product where major accidents or losses could occur if the product fails, install appropriate backup or failsafe functions in the system.

## Note

- If in doubt at any stage during the installation of the product, always consult a professional electrical engineer who is qualified and trained in the local and national standards. If in doubt about the operation or use, please consult the nearest Mitsubishi Electric representative.
- Since the examples indicated by this manual, technical bulletin, catalog, etc. are used as a reference, please use it after confirming the function and safety of the equipment and system. Mitsubishi Electric will accept no responsibility for actual use of the product based on these illustrative examples.
- This manual content, specification etc. may be changed, without a notice, for improvement.
- The information in this manual has been carefully checked and is believed to be accurate; however, if you notice a doubtful point, an error, etc., please contact the nearest Mitsubishi Electric representative. When doing so, please provide the manual number given at the end of this manual.

# MEMO

---

# CONTENTS

---

SAFETY PRECAUTIONS .....	1
INTRODUCTION .....	4
RELEVANT MANUALS .....	8
TERMS .....	9

## PART 1 MODBUS SERIAL COMMUNICATION

---

<b>CHAPTER 1 OUTLINE</b> .....	<b>12</b>
1.1 Outline of Function .....	12
1.2 Procedure for Operation .....	13
<b>CHAPTER 2 CONFIGURATION</b> .....	<b>14</b>
2.1 System Configuration .....	14
<b>CHAPTER 3 SPECIFICATIONS</b> .....	<b>16</b>
3.1 Communication Specifications .....	16
3.2 Link Time .....	17
<b>CHAPTER 4 MODBUS COMMUNICATION SPECIFICATIONS</b> .....	<b>20</b>
4.1 MODBUS Protocol .....	20
Frame mode .....	21
List of supported MODBUS standard functions .....	21
<b>CHAPTER 5 WIRING</b> .....	<b>22</b>
5.1 Wiring Procedure .....	22
5.2 Selecting Connection .....	22
For RS-232C .....	22
For RS-485 .....	22
Connecting cables .....	23
Termination resistor setting .....	24
5.3 Connection Diagram .....	25
Connection diagram for RS-232C .....	25
Connection diagram for RS-485 .....	25
5.4 Grounding .....	26
<b>CHAPTER 6 COMMUNICATION SETTING</b> .....	<b>27</b>
6.1 Setup Method for MODBUS Serial Communication .....	27
Using the CPU module .....	27
Using an Extended board .....	28
Using an Expansion adapter .....	29
Contents of parameter setting .....	29
<b>CHAPTER 7 FUNCTION</b> .....	<b>32</b>
7.1 Master Function .....	32
7.2 Slave Function .....	35



7.3	<b>Related Devices</b> .....	35
	List of related devices .....	35
	Details of Related Devices .....	37
<b>CHAPTER 8 CREATING PROGRAMS</b>		<b>43</b>
8.1	<b>Creating Programs for the Master Station</b> .....	43
8.2	<b>Cautions on Program Creation</b> .....	44
<b>PART 2 MODBUS/TCP COMMUNICATION</b>		
<hr/>		
<b>CHAPTER 9 OUTLINE</b>		<b>46</b>
9.1	<b>Outline of Function</b> .....	46
9.2	<b>Procedure for Operation</b> .....	47
<b>CHAPTER 10 SPECIFICATIONS</b>		<b>48</b>
10.1	<b>Communication Specifications</b> .....	48
<b>CHAPTER 11 MODBUS/TCP COMMUNICATION SPECIFICATIONS</b>		<b>50</b>
11.1	<b>MODBUS Protocol</b> .....	50
	Frame specifications .....	50
	List of supported MODBUS standard functions .....	50
<b>CHAPTER 12 COMMUNICATION SETTING</b>		<b>52</b>
12.1	<b>Setup Method for Port No.</b> .....	52
12.2	<b>Setup Method for MODBUS/TCP Communication</b> .....	52
	Contents of parameter setting .....	53
<b>CHAPTER 13 FUNCTION</b>		<b>55</b>
13.1	<b>Master Function</b> .....	55
13.2	<b>Slave Function</b> .....	57
13.3	<b>Related Devices</b> .....	58
	Details of Related Devices .....	58
<b>APPENDIX</b>		<b>59</b>
<b>Appendix 1 Troubleshooting</b> .....		59
	MODBUS serial communication .....	59
	MODBUS/TCP communication .....	59
<b>Appendix 2 Error code</b> .....		60
<b>Appendix 3 The frame specifications</b> .....		63
	Procedure for generating of CRC .....	63
	MODBUS protocol data unit formats .....	65
<b>Appendix 4 Initial values of MODBUS device allocation</b> .....		75
<b>Appendix 5 Added and Enhanced Functions</b> .....		77
<b>INDEX</b>		<b>78</b>
<hr/>		
	REVISIONS .....	80
	WARRANTY .....	81
	TRADEMARKS .....	82

# RELEVANT MANUALS

Manual name <manual number>	Description
MELSEC iQ-F FX5 User's Manual (Startup) <JY997D58201>	Performance specifications, procedures before operation, and troubleshooting of the CPU module.
MELSEC iQ-F FX5UJ User's Manual (Hardware) <SH-082206ENG>	Describes the details of hardware of the FX5UJ CPU module, including input/output specifications, wiring, installation, and maintenance.
MELSEC iQ-F FX5U User's Manual (Hardware) <JY997D55301>	Describes the details of hardware of the FX5U CPU module, including input/output specifications, wiring, installation, and maintenance.
MELSEC iQ-F FX5UC User's Manual (Hardware) <JY997D61401>	Describes the details of hardware of the FX5UC CPU module, including input/output specifications, wiring, installation, and maintenance.
MELSEC iQ-F FX5 User's Manual (Application) <JY997D55401>	Describes basic knowledge required for program design, functions of the CPU module, devices/labels, and parameters.
MELSEC iQ-F FX5 Programming Manual (Program Design) <JY997D55701>	Describes specifications of ladders, ST, FBD/LD, and other programs and labels.
MELSEC iQ-F FX5 Programming Manual (Instructions, Standard Functions/Function Blocks) <JY997D55801>	Describes specifications of instructions and functions that can be used in programs.
MELSEC iQ-F FX5 User's Manual (Serial Communication) <JY997D55901>	Describes N:N network, Parallel link, MELSEC Communication protocol, inverter communication, non-protocol communication, and predefined protocol support.
MELSEC iQ-F FX5 User's Manual (MELSEC Communication Protocol) <JY997D60801>	Explains methods for the device that is communicating with the CPU module by MC protocol to read and write the data of the CPU module.
MELSEC iQ-F FX5 User's Manual (MODBUS Communication) <JY997D56101> (This manual)	Describes MODBUS serial communication and MODBUS/TCP communication.
MELSEC iQ-F FX5 User's Manual (PROFIBUS) <SH-081910ENG>	Describes the functions of the PROFIBUS-DP master module.
MELSEC iQ-F FX5 User's Manual (Ethernet Communication) <JY997D56201>	Describes the Ethernet communication function of the CPU module built-in and the Ethernet module.
MELSEC iQ-F FX5-ENET User's Manual <SH-082026ENG>	Describes the functions of the Ethernet module.
MELSEC iQ-F FX5-ENET/IP User's Manual <SH-082027ENG>	Describes the functions of the FX5-ENET/IP.
MELSEC iQ-F FX5 User's Manual (SLMP) <JY997D56001>	Explains methods for the device that is communicating with the CPU module by SLMP to read and write the data of the CPU module.
MELSEC iQ-F FX5 User's Manual (CC-Link IE) <JY997D64201>	Describes CC-Link IE field network module.
MELSEC iQ-F FX5 User's Manual (CC-Link) <SH-081793ENG>	Describes CC-Link system master/intelligent device module.
MELSEC iQ-F FX5 User's Manual (AnyWireASLINK) <SH-081796ENG>	Describes AnyWireASLINK system master module.
MELSEC iQ-F FX5 User's Manual (Positioning Control - CPU module built-in, High-speed pulse input/output module) <JY997D56301>	Describes the positioning function of the CPU module built-in and the high-speed pulse input/output module.
MELSEC iQ-F FX5 User's Manual (Positioning Control - Intelligent function module) <SH-081805ENG>	Describes the positioning module.
MELSEC iQ-F FX5 Simple Motion Module User's Manual (Startup) <IB0300251>	Specifications, procedures before operation, system configuration, wiring, and operation examples of the Simple Motion module.
MELSEC iQ-F FX5 Simple Motion Module User's Manual (Application) <IB0300253>	Functions, input/output signals, buffer memories, parameter settings, programming, and troubleshooting of the Simple Motion module.
MELSEC iQ-F FX5 Simple Motion Module User's Manual (Advanced Synchronous Control) <IB0300255>	Functions and programming for the synchronous control of the Simple Motion module.
MELSEC iQ-F FX5 User's Manual (Analog Control - CPU module built-in, Expansion adapter) <JY997D60501>	Describes the analog function of the CPU module built-in and the analog adapter.
MELSEC iQ-F FX5 User's Manual (Analog Control - Intelligent function module) <SH-081802ENG>	Describes the analog input module, analog output module, and multiple input module.
MELSEC iQ-F FX5 User's Manual (Temperature Control) <SH-081799ENG>	Describes the temperature control module.

Manual name <manual number>	Description
MELSEC iQ-F FX5 User's Manual (Safety Control) <SH-082078ENG>	Describes the safety extension modules.
GX Works3 Operating Manual <SH-081215ENG>	System configuration, parameter settings, and online operations of GX Works3.
Transition from MELSEC FX3G, FX3U, FX3UC Series to MELSEC iQ-F Series Handbook <JY997D66201>	Describes the transition from MELSEC FX3G/FX3U/FX3UC series to MELSEC iQ-F series.

## TERMS

Unless otherwise specified, this manual uses the following terms.

For details on the FX3 devices that can be connected with the FX5, refer to the User's Manual (Hardware) of the CPU module to be used.

Terms	Description
■Devices	
FX5	Generic term for FX5UJ, FX5U and FX5UC PLCs
FX3	Generic term for FX3S, FX3G, FX3GC, FX3U, and FX3UC PLCs
FX5 CPU module	Generic term for FX5UJ CPU module, FX5U CPU module and FX5UC CPU module
FX5UJ CPU module	Generic term for FX5UJ-24MR/ES, FX5UJ-24MT/ES, FX5UJ-24MT/ESS, FX5UJ-40MR/ES, FX5UJ-40MT/ES, FX5UJ-40MT/ESS, FX5UJ-60MR/ES, FX5UJ-60MT/ES, and FX5UJ-60MT/ESS
FX5U CPU module	Generic term for FX5U-32MR/ES, FX5U-32MT/ES, FX5U-32MT/ESS, FX5U-64MR/ES, FX5U-64MT/ES, FX5U-64MT/ESS, FX5U-80MR/ES, FX5U-80MT/ES, FX5U-80MT/ESS, FX5U-32MR/DS, FX5U-32MT/DS, FX5U-32MT/DSS, FX5U-64MR/DS, FX5U-64MT/DS, FX5U-64MT/DSS, FX5U-80MR/DS, FX5U-80MT/DS, and FX5U-80MT/DSS
FX5UC CPU module	Generic term for FX5UC-32MT/D, FX5UC-32MT/DSS, FX5UC-64MT/D, FX5UC-64MT/DSS, FX5UC-96MT/D, FX5UC-96MT/DSS, FX5UC-32MT/DS-TS, FX5UC-32MT/DSS-TS, and FX5UC-32MR/DS-TS
Extension module	Generic term for FX5 extension modules, FX3 function modules, Extension modules (extension cable type) and Extension module (extension connector type)
FX5 extension module	Generic term for I/O modules, FX5 extension power supply modules, FX5 intelligent function modules, and FX5 safety extension modules
FX3 extension module	Generic term for FX3 extension power supply module and FX3 intelligent function module
Extension module (extension cable type)	Generic term for Input modules (extension cable type), Output modules (extension cable type), Input/output modules (extension cable type), Powered input/output module, High-speed pulse input/output module, Extension power supply module (extension cable type), Connector conversion module (extension cable type), Intelligent function modules, Safety extension modules, and Bus conversion module (extension cable type)
Extension module (extension connector type)	Generic term for Input modules (extension connector type), Output modules (extension connector type), Input/output modules (extension connector type), Extension power supply module (extension connector type), Connector conversion module (extension connector type), and Bus conversion module (extension connector type)
I/O module	Generic term for Input modules, Output modules, Input/output modules, Powered input/output modules, and High-speed pulse input/output modules
Input module	Generic term for Input modules (extension cable type) and Input modules (extension connector type)
Input module (extension cable type)	Generic term for FX5-8EX/ES and FX5-16EX/ES
Input module (extension connector type)	Generic term for FX5-C16EX/D, FX5-C16EX/DS, FX5-C32EX/D, FX5-C32EX/DS, and FX5-C32EX/DS-TS
Output module	Generic term for Output modules (extension cable type) and Output modules (extension connector type)
Output module (extension cable type)	Generic term for FX5-8EYR/ES, FX5-8EYT/ES, FX5-8EYT/ESS, FX5-16EYR/ES, FX5-16EYT/ES, and FX5-16EYT/ESS
Output module (extension connector type)	Generic term for FX5-C16EYT/D, FX5-C16EYT/DSS, FX5-C16EYR/D-TS, FX5-C32EYT/D, FX5-C32EYT/DSS, FX5-C32EYT/D-TS, and FX5-C32EYT/DSS-TS
Input/output module	Generic term for Input/output modules (extension cable type) and Input/output modules (extension connector type)
Input/output module (extension cable type)	Generic term for FX5-16ER/ES, FX5-16ET/ES, and FX5-16ET/ESS
Input/output module (extension connector type)	Generic term for FX5-C32ET/D, FX5-C32ET/DSS, FX5-C32ET/DS-TS, and FX5-C32ET/DSS-TS
Powered input/output module	Generic term for FX5-32ER/ES, FX5-32ET/ES, FX5-32ET/ESS, FX5-32ER/DS, FX5-32ET/DS, and FX5-32ET/DSS
High-speed pulse input/output module	Generic term for FX5-16ET/ES-H and FX5-16ET/ESS-H
Extension power supply module	Generic term for FX5 extension power supply module and FX3 extension power supply module

Terms	Description
FX5 extension power supply module	Generic term for FX5 extension power supply module (extension cable type) and FX5 extension power supply module (extension connector type)
FX5 extension power supply module (extension cable type)	Different name for FX5-1PSU-5V
FX5 extension power supply module (extension connector type)	Different name for FX5-C1PS-5V
FX3 extension power supply module	Different name for FX3U-1PSU-5V
Intelligent module	The abbreviation for intelligent function modules
Intelligent function module	Generic term for FX5 intelligent function modules and FX3 intelligent function modules
FX5 intelligent function module	Generic term for FX5-4AD, FX5-4DA, FX5-8AD, FX5-4LC, FX5-20PG-P, FX5-20PG-D, FX5-40SSC-S, FX5-80SSC-S, FX5-ENET, FX5-ENET/IP, FX5-CCLIEF, FX5-CCL-MS, FX5-ASL-M, and FX5-DP-M
FX3 intelligent function module	Generic term for FX3U-4AD, FX3U-4DA, FX3U-4LC, FX3U-1PG, FX3U-2HC, FX3U-16CCL-M, FX3U-64CCL, FX3U-128ASL-M, and FX3U-32DP
FX5 safety extension module	Generic term for safety main modules and safety expansion modules
Safety main module	Different name for FX5-SF-MU4T5
Safety expansion module	Generic term for expansion modules installed to a safety main module
Safety input expansion module	Different name for FX5-SF-8DI4
Expansion board	Generic term for board for FX5UJ CPU module and FX5U CPU module
Communication board	Generic term for FX5-232-BD, FX5-485-BD, and FX5-422-BD-GOT
Expansion adapter	Generic term for adapter for FX5 CPU module
Communication adapter	Generic term for FX5-232ADP and FX5-485ADP
Analog adapter	Generic term for FX5-4AD-ADP, FX5-4DA-ADP, FX5-4AD-PT-ADP, and FX5-4AD-TC-ADP
Bus conversion module	Generic term for Bus conversion module (extension cable type) and Bus conversion module (extension connector type)
Bus conversion module (extension cable type)	Different name for FX5-CNV-BUS
Bus conversion module (extension connector type)	Different name for FX5-CNV-BUSC
Connector conversion module	Generic term for Connector conversion module (extension cable type) and Connector conversion module (extension connector type)
Connector conversion module (extension cable type)	Different name for FX5-CNV-IF
Connector conversion module (extension connector type)	Different name for FX5-CNV-IFC
Extended extension cable	Generic term for FX5-30EC and FX5-65EC
Connector conversion adapter	Different name for FX5-CNV-BC
Battery	Different name for FX3U-32BL
Peripheral device	Generic term for engineering tools and GOTs
GOT	Generic term for Mitsubishi Electric Graphic Operation Terminal GOT1000 and GOT2000 series
<b>■Software packages</b>	
Engineering tool	The product name of the software package for the MELSEC programmable controllers
GX Works3	The product name of the software package, SWnDND-GXW3, for the MELSEC programmable controllers (The 'n' represents a version.)
<b>■Communication-related</b>	
Built-in RS-485 port	CPU module built-in RS-485 port
Serial port	Generic name for CPU module built-in RS-485 port (CH1), communication board (CH2), communication adapter 1 (CH3), communication adapter 2 (CH4) (4 ports)

This part consists of the following chapters.

1 OUTLINE

---

2 CONFIGURATION

---

3 SPECIFICATIONS

---

4 MODBUS COMMUNICATION SPECIFICATIONS

---

5 WIRING

---

6 COMMUNICATION SETTING

---

7 FUNCTION

---

8 CREATING PROGRAMS

---

# 1 OUTLINE

This chapter explains the FX5 MODBUS serial communication.

- When predefined protocol support function is used, refer to the MELSEC iQ-F FX5 User's Manual (Serial Communication).

## 1.1 Outline of Function

The FX5 MODBUS serial communication function can control 32 slaves for RS-485 communication and one slave for RS-232C communication by a single master.

- The master function and slave function are supported and the master and slave can be used simultaneously by a single FX5. (Only one channel for the master)
- Up to 4 channels<sup>\*1</sup> can be used for MODBUS serial communication function by one CPU module.
- The master uses a PLC command dedicated to MODBUS serial communication and controls the slave.
- The communication protocol supports the RTU mode.

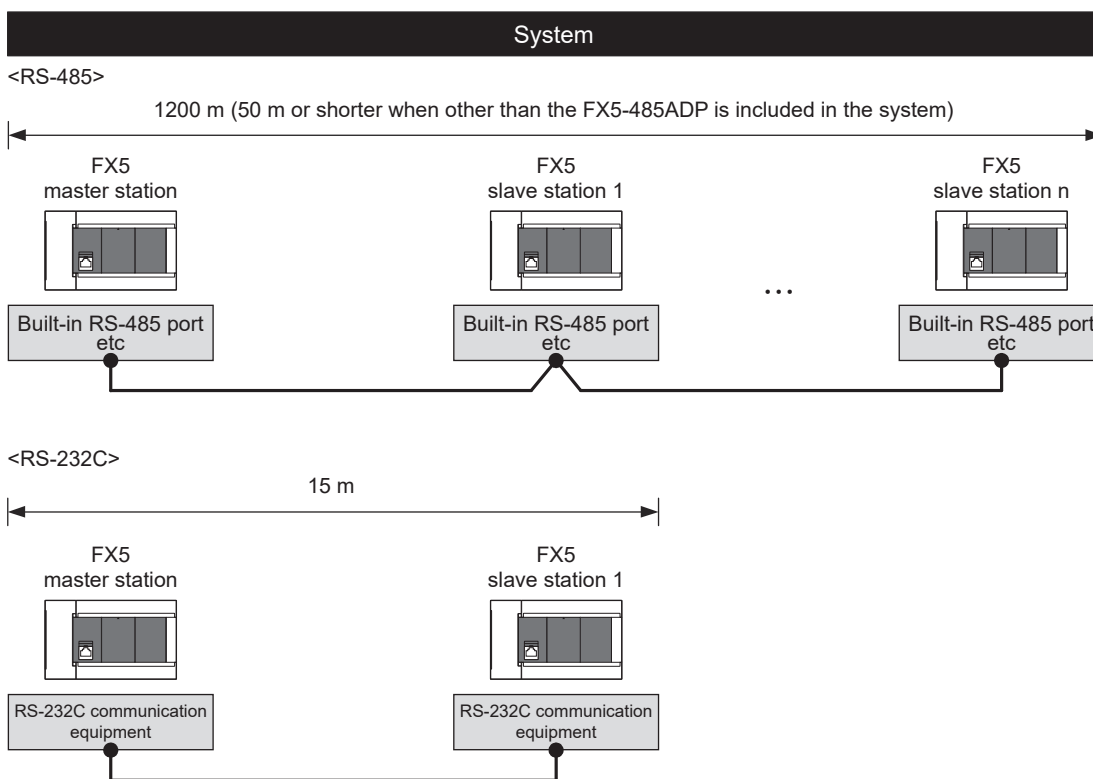

### Point

The slave station No. can be set from 1 to 247<sup>\*2</sup>. However, the number of slave station which can be connected to the FX5 master station is 32.

\*1 Maximum number of channels differs depending on the CPU module. ( Page 14 System Configuration)

\*2 Slave station No. that can be set in FX5 master station differs depending on the version. ( Page 77 Added and Enhanced Functions)

# 1.2 Procedure for Operation

The flow chart below shows the procedure for setting up a MODBUS serial communication network:

## 1. Check communication specifications

☞ Refer to Page 16 SPECIFICATIONS or Page 20 MODBUS COMMUNICATION SPECIFICATIONS

- Communication Specifications

Link Time

- MODBUS Serial Communication Specifications

MODBUS Serial Communication Protocol, Details of MODBUS Standard Functions

## 2. System configuration and selection

☞ Refer to Page 14 CONFIGURATION

- System Configuration

Selection of communication equipment

## 3. Wiring

☞ Refer to Page 22 WIRING

- Wiring procedure

Wiring example

## 4. Communication settings

☞ Refer to Page 27 COMMUNICATION SETTING

- Communication setting using GX Works3<sup>\*1</sup>

\*1 For details on the connection method or operation method to the PLC of GX Works3, refer to the following manual.

☞ GX Works3 Operating Manual

Setting parameters, Related special device

## 5. Program creation

☞ Refer to Page 32 FUNCTION or Page 43 CREATING PROGRAMS

- Function

Master function, Slave function, Related special device

- MODBUS serial communication program

Example of creating programs of the master using ADPRW instruction

# 2 CONFIGURATION

This chapter explains the configuration of RS-485 and RS-232C communication of the FX5.

## 2.1 System Configuration

This section outlines the system configuration required to use MODBUS serial communication.

### FX5UJ CPU module

In FX5UJ CPU module, up to two communication port channels can be connected to a CPU module using communication board, and communication adapter.

Communication channel assignments are fixed regardless of the system configuration.

The combinations which can be configured are shown below.

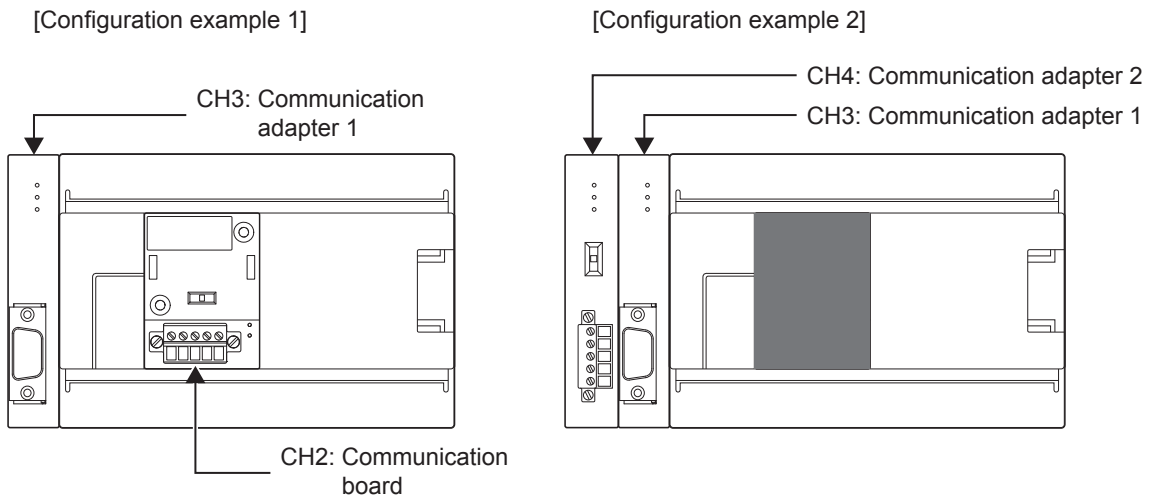

		Communication port	Important point in selection	Total extension distance
Communication board	FX5-485-BD	CH2	Mounted on top of the CPU module, there is no change in the installation space requirements	50 m or less
	FX5-232-BD			15 m or less
Communication adapter	FX5-485ADP	CH3, CH4*1	Mount the communication adapter to the left of the CPU module	1200 m or less
	FX5-232ADP			15 m or less

\*1 Assigned to CH3 or CH4 in order of proximity to CPU module.



## FX5U CPU module

In FX5U CPU module, up to four communication port channels can be connected to a CPU module using built-in RS-485 port, communication board, and communication adapter.

Communication channel assignments are fixed regardless of the system configuration.

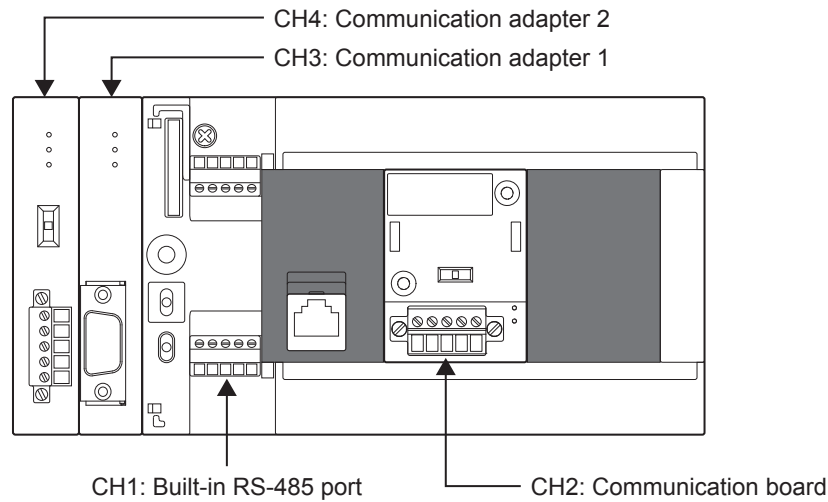

		Communication port	Important point in selection	Total extension distance
Built-in RS-485 port		CH1	Since it is built-into the CPU module, there is no need to add equipment	50 m or less
Communication board	FX5-485-BD	CH2	Mounted on top of the CPU module, there is no change in the installation space requirements	50 m or less
	FX5-232-BD			15 m or less
Communication adapter	FX5-485ADP	CH3, CH4*1	Mount the communication adapter to the left of the CPU module	1200 m or less
	FX5-232ADP			15 m or less

\*1 Assigned to CH3 or CH4 in order of proximity to CPU module.

## FX5UC CPU module

In FX5UC CPU module, up to three communication port channels can be connected to a CPU module using built-in RS-485 port, and communication adapter.

Communication channel assignments are fixed regardless of the system configuration.

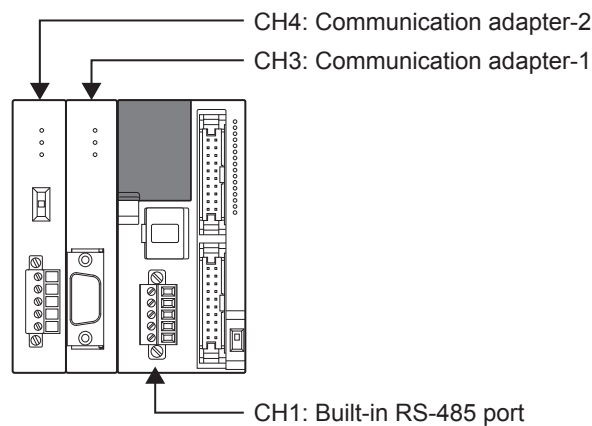

		Communication port	Important point in selection	Total extension distance
Built-in RS-485 port		CH1	Since it is built-into the CPU module, there is no need to add equipment	50 m or less
Communication adapter	FX5-485ADP	CH3, CH4*1	Mount the communication adapter to the left of the CPU module	1200 m or less
	FX5-232ADP			15 m or less

\*1 Assigned to CH3 or CH4 in order of proximity to CPU module.

# 3 SPECIFICATIONS

This chapter explains the specifications of MODBUS serial communication.

## 3.1 Communication Specifications

MODBUS serial communication is executed within the specifications shown in the table below. The baud rate, etc. can be changed in the parameter settings of GX Works3.

Item	Specifications		Remarks	
	Built-in RS-485 port FX5-485-BD FX5-485ADP	FX5-232-BD FX5-232ADP		
Number of connectable units	Up to 4 Channel*1 (Only one channel for the master)		The channel can be used as master or slave.	
Communication specifications	Communication interface	RS-485	RS-232C	—
	Baud rate	300/600/1200/2400/4800/9600/19200/38400/57600/115200 bps		—
	Data length	8 bit		—
	Parity bit	None, odd or even		—
	Stop bit	1 bit/2 bit		—
	Transmission distance	1200 m or less for the system configured with FX5-485ADP only 50 m or less for the system configured with devices other than above	15 m or less	The transmission distance varies depending on communication equipment type.
	Communication protocol	RTU		—
Master function	Number of connectable slaves	32 slaves	1 slave	The number of slaves varies depending on communication equipment type.
	Number of functions	8 (No diagnosis function)		—
	Number of simultaneous sending messages	1 message		—
	Maximum number of writes	123 words or 1968 coils		—
	Maximum number of reads	125 words or 2000 coils		—
Slave function	Number of functions	8 (No diagnosis function)		—
	Number of messages which can be received simultaneously	1 message		—
	Station number	1 to 247		—

\*1 Maximum number of channels differs depending on the CPU module. (Page 14 System Configuration)

## 3.2 Link Time

The link time indicates the cycle time in which a master module completes a single instruction with a slave, as illustrated by the diagram below.

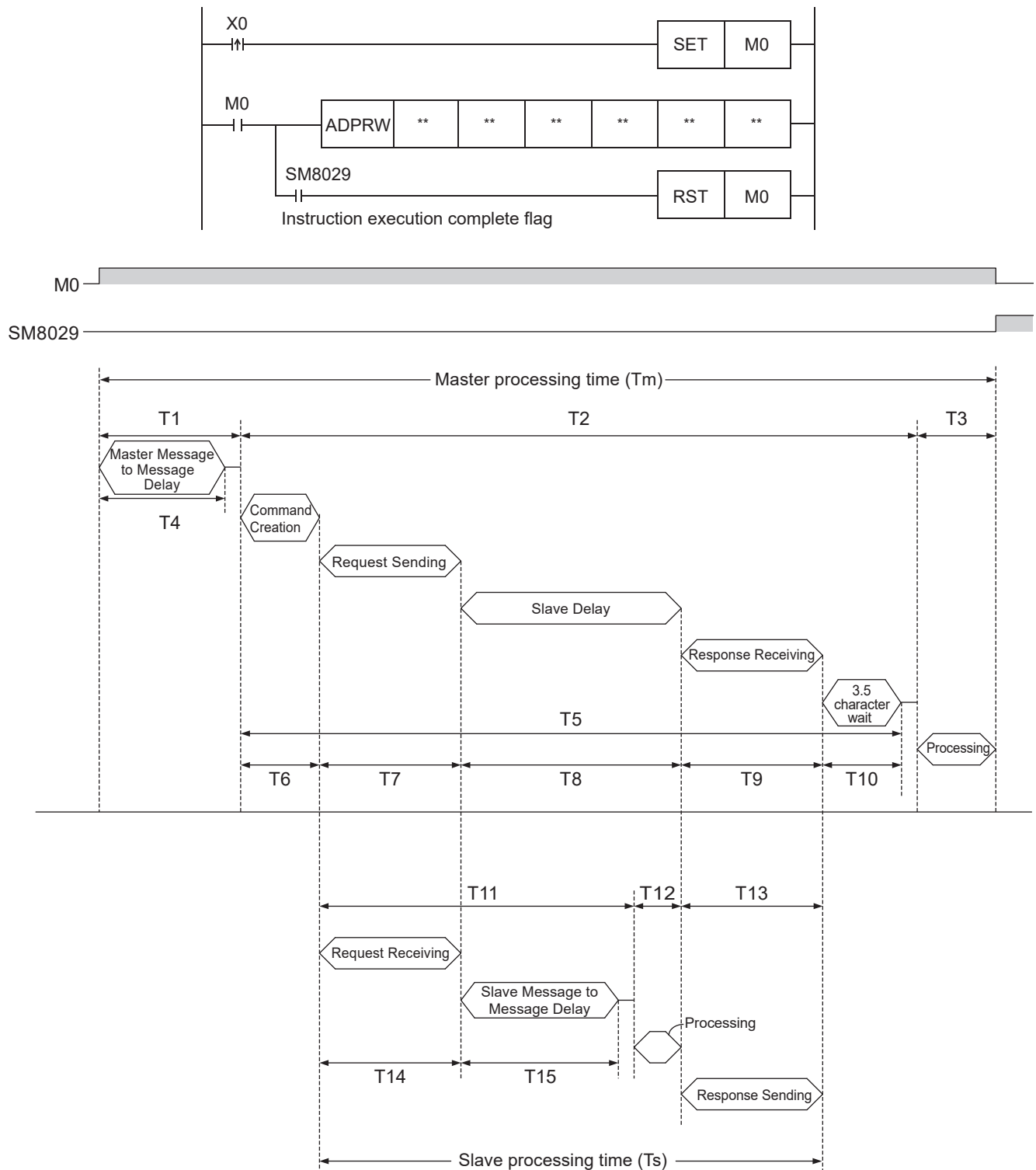

The master processing time (T<sub>m</sub>) can be calculated in milliseconds (ms) as follows. "INT(n)" indicates an integer obtained by truncating decimal places of "n".

Character length (bits):

Start bit (1 bit) + Data Length (8 bit) + Parity bit (0 bit or 1 bit) + Stop bit (1 bit or 2 bit)

$$T_m = T_1 + T_2 + T_3$$

$$T_1 = \left( \text{INT} \left( \frac{T_4}{\text{Max. Scan Time}} \right) + 1 \right) \times \text{Max. Scan Time}$$

T<sub>4</sub> = SD8864, SD8874, SD8884, or SD8894 (depending on the communication channel)

$$T_2 = \left( \text{INT} \left( \frac{T_5}{\text{Max. Scan Time}} \right) + 1 \right) \times \text{Max. Scan Time}$$

T<sub>5</sub> = T<sub>6</sub> + T<sub>7</sub> + T<sub>8</sub> + T<sub>9</sub> + T<sub>10</sub>

T<sub>6</sub> = less than 1 ms

$$T_7 = \frac{\text{Number of Bytes in Request} \times \text{Character Length (bits)}}{\text{Baud Rate (bps)}} \times 1000 \text{ (ms)} + 1 \text{ ms}$$

T<sub>8</sub> = Slave delay time (depending on the slave)

$$T_9 = \frac{\text{Number of Bytes in Response} \times \text{Character Length (bits)}}{\text{Baud Rate (bps)}} \times 1000 \text{ (ms)} + 1 \text{ ms}$$

$$T_{10} = \frac{3.5 \text{ Characters} \times \text{Character Length (bits)}}{\text{Baud Rate (bps)}} \times 1000 \text{ (ms)} + 1 \text{ ms}$$

T<sub>3</sub> = less than 1 ms

The slave processing time (T<sub>s</sub>) can be calculated in milliseconds (ms) as follows.

Character length (bits):

Start bit (1 bit) + Data Length (8 bit) + Parity bit (0 bit or 1 bit) + Stop bit (1 bit or 2 bit)

$$T_s = T_{11} + T_{12} + T_{13}$$

$$T_{11} = T_{14} + T_{15} + \text{Max. Scan Time}$$

$$T_{14} = \frac{\text{Number of Bytes in Request} \times \text{Character Length (bits)}}{\text{Baud Rate (bps)}} \times 1000 \text{ (ms)} + 1 \text{ ms}$$

T<sub>15</sub> = SD8864, SD8874, SD8884, or SD8894 (depending on the communication channel)

T<sub>12</sub> = less than 1 ms

$$T_{13} = \frac{\text{Number of Bytes in Response} \times \text{Character Length (bits)}}{\text{Baud Rate (bps)}} \times 1000 \text{ (ms)} + 1 \text{ ms}$$

## Example link time calculations:

### Master processing time (Tm)

SD8864	=	5 ms
Max. scan time	=	5 ms
Function	=	Read holding registers 0 to 9 (function code: 03H)
Frame mode	=	RTU mode
Number of bytes in request	=	8 bytes (1 byte Address, 5 byte Frame, 2 byte CRC)
Number of bytes in response	=	25 bytes (1 byte Address echo, 22 byte Frame, 2 byte CRC)
Character length	=	10 bits (1 bit Start bit, 8 bit Data length, 0 bit Parity bit, 1 bit Stop bit)
Baud rate	=	19.2 kbps
Slave delay time	=	10 ms

$$T4 = 5 \text{ ms}$$

$$T1 = \left( \text{INT} \left( \frac{5 \text{ ms}}{5 \text{ ms}} \right) + 1 \right) \times 5 \text{ ms} = (1 + 1) \times 5 \text{ ms} = 10 \text{ ms}$$

$$T6 \approx 1 \text{ ms}$$

$$T7 = \frac{8 \text{ Bytes} \times 10 \text{ Bits}}{19200 \text{ bps}} \times 1000 \text{ (ms)} + 1 \text{ ms} \approx 5.2 \text{ ms}$$

$$T8 = 10 \text{ ms}$$

$$T9 = \frac{25 \text{ Bytes} \times 10 \text{ Bits}}{19200 \text{ bps}} \times 1000 \text{ (ms)} + 1 \text{ ms} \approx 14.0 \text{ ms}$$

$$T10 = \frac{3.5 \text{ Characters} \times 10 \text{ Bits}}{19200 \text{ bps}} \times 1000 \text{ (ms)} + 1 \text{ ms} \approx 2.8 \text{ ms}$$

$$T5 = 1 \text{ ms} + 5.2 \text{ ms} + 10 \text{ ms} + 14.0 \text{ ms} + 2.8 \text{ ms} = 33 \text{ ms}$$

$$T2 = \left( \text{INT} \left( \frac{33 \text{ ms}}{5 \text{ ms}} \right) + 1 \right) \times 5 \text{ ms} = (6 + 1) \times 5 \text{ ms} = 35 \text{ ms}$$

$$T3 \approx 1 \text{ ms}$$

$$Tm = 5 \text{ ms} + 35 \text{ ms} + 1 \text{ ms} = \underline{41 \text{ ms}}$$

### Slave processing time (Ts)

Function	=	Read holding registers 0 to 9 (function code: 03H)
Frame mode	=	RTU mode
Number of bytes in request	=	8 bytes (1 byte Address, 5 byte Frame, 2 byte CRC)
Number of bytes in response	=	25 bytes (1 byte Address echo, 22 byte Frame, 2 byte CRC)
Character length	=	10 bits (1 bit Start bit, 8 bit Data length, 0 bit Parity bit, 1 bit Stop bit)
Baud rate	=	19.2 kbps
SD8864	=	5 ms
Max. scan time	=	5 ms

$$T14 = \frac{8 \text{ Bytes} \times 10 \text{ Bits}}{19200 \text{ bps}} \times 1000 \text{ (ms)} + 1 \text{ ms} \approx 5.2 \text{ ms}$$

$$T15 = 5 \text{ ms}$$

$$T11 = 5.2 \text{ ms} + 5 \text{ ms} + 5 \text{ ms} = 15.2 \text{ ms}$$

$$T12 \approx 1 \text{ ms}$$

$$T13 = \frac{25 \text{ Bytes} \times 10 \text{ Bits}}{19200 \text{ bps}} \times 1000 \text{ (ms)} + 1 \text{ ms} \approx 14.0 \text{ ms}$$

$$Ts = 15.2 \text{ ms} + 1 \text{ ms} + 14.0 \text{ ms} = \underline{30.2 \text{ ms}}$$

# 4 MODBUS COMMUNICATION SPECIFICATIONS

This chapter explains the details of MODBUS Protocol for MODBUS serial communication and the MODBUS standard functions supported by the FX5.

- For the list of supported MODBUS standard functions, refer to [Page 21](#) List of supported MODBUS standard functions.
- For usage of the supported MODBUS standard functions, refer to [Page 32](#) FUNCTION.

## 4.1 MODBUS Protocol

The following shows the frame specifications for the MODBUS protocol.

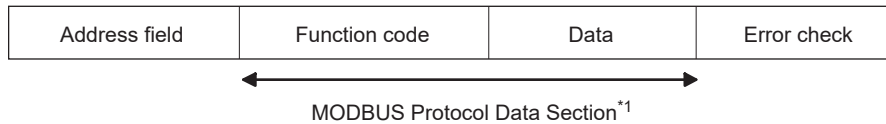

\*1 For details of the MODBUS protocol data section, refer to [Page 65](#).

The following table details the frame specifications for the MODBUS Protocol.

Area name	Description
Address field	[When the master sends a request message to a slave] 0: Sends a request message to all the slaves. (Broadcast) 1 to 247: Sends a request to a specific Slave number. Note: 247 is the MODBUS maximum address number.*1 [When the slave sends a response message to the master] The host station number is stored when sending a response message.
Function code	[When the master sends a request message to a slave] The master specifies the function code to the slave. [When the slave sends a response message to the master] The requested function code is stored in the case of normal completion. The most significant bit turns ON in the case of abnormal end.
Data	[When the master sends a request message to a slave] The information needed to execute the action specified by a function code is stored. [When the slave sends a response message to the master] The execution result of the action specified by a function code is stored. An exception code is stored when failed.
Error check	The node (master or slave) adds the check code automatically to all transmitted messages and recalculates the check code for any received message. The received message is discarded if it has an error.

\*1 The address number that can be used in FX5 master station differs depending on the version. ([Page 77](#) Added and Enhanced Functions)

Refer to [Page 21](#) Frame mode for the data size of each area.

# Frame mode

For the FX5, the following frame modes are available. If the frame mode of the FX5 differs from the one of the target device, it cannot be used.

## Available frame modes

### ■RTU mode

In this mode, frames are received or sent in binary codes.

The frame specifications are compliant with the MODBUS protocol specifications.

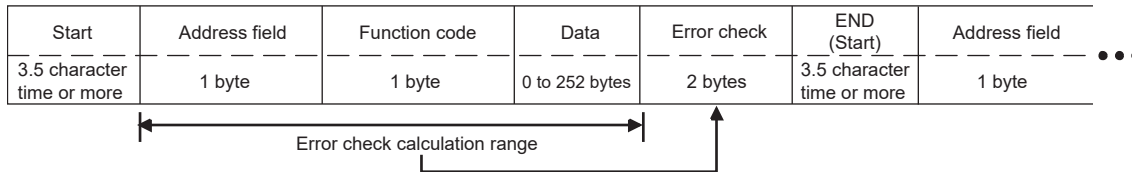

### Point

The error check in the RTU mode is conducted by CRC (Cyclic Redundancy Check).

The CRC field is two bytes, containing a 16 bit binary value. The CRC value is calculated by the transmitting device, which appends the CRC to the message. The device that receives recalculates a CRC during receipt of the message, and compares the calculated value to the actual value it received in the CRC field. If the two values are not equal, an error occurs. (For procedure for generating of CRC, refer to Page 63 The frame specifications)

## List of supported MODBUS standard functions

The following table lists the MODBUS standard functions supported by the FX5.

Function code	Function Name	Details	Accessible devices per message	Broadcast	Reference
01H	Read coils	Read binary (R/W) devices	1 to 2000 points	×	Page 66
02H	Read inputs	Read binary (RO) devices	1 to 2000 points	×	Page 67
03H	Read holding registers	Read 16 bit (R/W) registers	1 to 125 points	×	Page 68
04H	Read input registers	Read 16 bit (RO) registers	1 to 125 points	×	Page 69
05H	Write single coil	Write single binary device	1 point	○	Page 70
06H	Write single register	Write single 16 bit register device	1 point	○	Page 70
0FH	Write multiple coils	Write multiple binary (R/W) devices	1 to 1968 points	○	Page 71
10H	Write multiple registers	Write multiple 16 bit (R/W) registers	1 to 123 points	○	Page 72

○:Applicable, ×:Not applicable

# 5 WIRING

This chapter explains the wiring.

## 5.1 Wiring Procedure

### 1. Preparing for wiring

Prepare cables required for wiring. (☞ Page 22 Selecting Connection)

### 2. Turning off the power to the PLC

Before wiring, make sure that the power of the PLC is off.

### 3. Wiring communication equipment

Connect RS-485 or RS-232C communication equipment. (☞ Page 25 Connection Diagram)

## 5.2 Selecting Connection

Select cables using the procedure described below.

### For RS-232C

Use an RS-232C cable of the RS-232 standard within 15 m.

### For RS-485

Use shielded twisted pair cables for connecting RS-485 communication equipment.

#### Twisted pair cable

##### ■RS-485 cable specifications

Item	Description
Cable type	Shielded cable
Number of pairs	2p, 3p
Conductor resistance (20°C)	88.0 Ω/km or less
Insulation resistance	10000 MΩ·km or more
Dielectric strength	500 V DC, 1 minute
Electrostatic capacitance (1 kHz)	60 nF/km or less as an average
Characteristic impedance (100 kHz)	110±10 Ω

##### ■Cable structural drawing (reference)

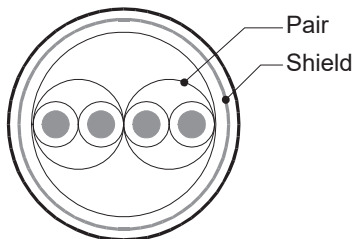

Example of two-pair cable structural drawing

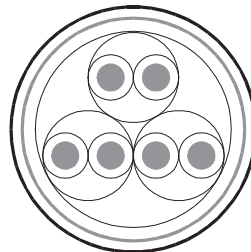

Example of three-pair cable structural drawing



# Connecting cables

The table below shows applicable cables and tightening torques.

	Number of connected electric wires per terminal	Cable size		Tightening torque
		Solid wire, Stranded wire	Wire ferrule with insulating sleeve	
FX5U CPU module built-in RS-485 port	1-wire connection	0.2 to 0.5 mm <sup>2</sup> (AWG24 to 20)	0.2 to 0.5 mm <sup>2</sup> (AWG24 to 20)	0.22 to 0.25 N·m
	2-wire connection	0.2 mm <sup>2</sup> (AWG24)	—	
FX5UC CPU module built-in RS-485 port FX5-485-BD FX5-485ADP	1-wire connection	0.3 to 0.5 mm <sup>2</sup> (AWG22 to 20)	0.3 to 0.5 mm <sup>2</sup> (AWG22 to 20)	
	2-wire connection	0.3 mm <sup>2</sup> (AWG22)	—	

## Precautions

Do not tighten terminal screws with torque beyond the specified range. Otherwise it may cause equipment failure or malfunction.

## Wire end treatment

With regard to the cable end treatment, use a stranded cable or solid cable as is, or use a wire ferrule with insulating sleeve.

### ■When using a stranded cable or solid cable as is

- Twist the end of stranded wire and make sure that there are no loose wires.
- Please do not solder plate the ends of the wires.

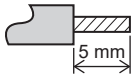
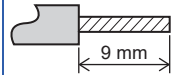
Dimension of the wire end	
FX5U CPU module built-in RS-485 port	FX5UC CPU module built-in RS-485 port, FX5-485-BD, FX5-485ADP
	

### ■When using a wire ferrule with insulating sleeve

Because it is difficult to insert a cable into the insulating sleeve depending on the thickness of the cable sheath, select the proper cable according to the outline drawing.

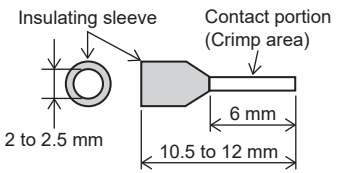
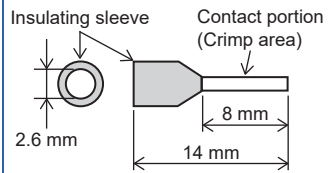
FX5U CPU module built-in RS-485 port	FX5UC CPU module built-in RS-485 port, FX5-485-BD, FX5-485ADP
	

<Reference>

	Manufacturer	Model name	Crimping tool
FX5U CPU module built-in RS-485 port	Phoenix Contact GmbH & Co. KG	AI 0.5-6WH	CRIMPFOX 6
FX5UC CPU module built-in RS-485 port FX5-485-BD FX5-485ADP		AI 0.5-8WH	CRIMPFOX 6T-F

## ■Tool

For tightening the terminal, use a commercially available small screwdriver with straight tip that is not widened toward the end as shown below.

### ■Precautions

If the diameter of the screwdriver tip is too small, the required tightening torque cannot be achieved. To achieve the appropriate tightening torque shown in the previous page, use the following screwdriver or its equivalent (grip diameter: approximately 25 mm).

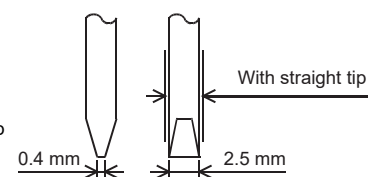

<Reference>

Manufacturer	Model
Phoenix Contact GmbH & Co. KG	SZS 0.4×2.5

# Termination resistor setting

Make sure to provide a termination resistor at each end of a line.

Built-in RS-485 port, FX5-485-BD, and FX5-485ADP have a built-in termination resistor.

Set the termination resistor selector switch accordingly.

Wiring	Termination resistor selector switch
Two-pair wiring	330 Ω
One-pair wiring	110 Ω

· FX5U CPU module built-in RS-485 port

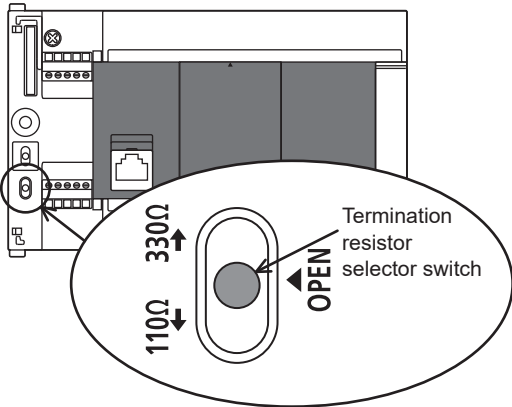

· FX5UC CPU module built-in RS-485 port

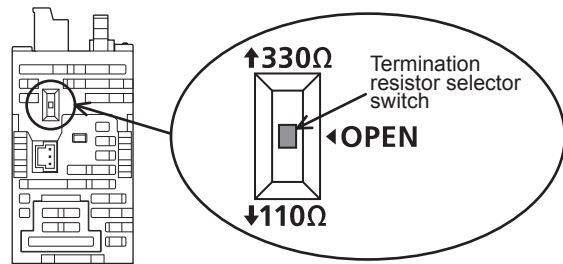

• FX5-485-BD

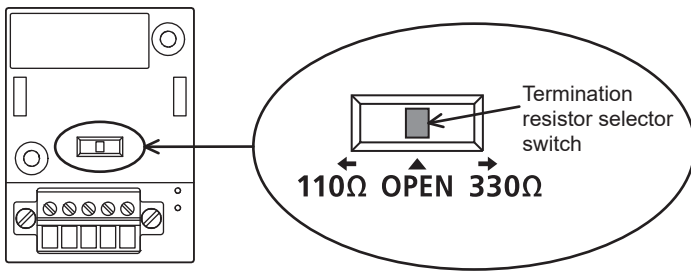

• FX5-485ADP

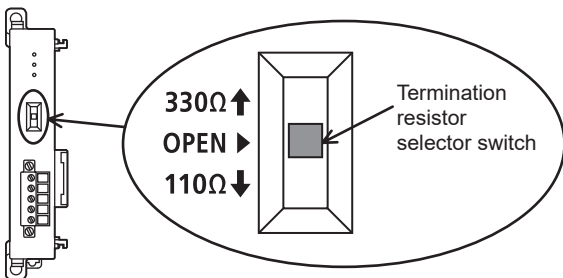

# 5.3 Connection Diagram

Representative wiring examples are shown in this section. When pin numbers in the counterpart equipment are different, wire the pins as shown below.

## Connection diagram for RS-232C

PLC		External equipment operating in accordance with RS-232C					
Name	FX5-232-BD FX5-232ADP 9-pin D-Sub	Using CS and RS		Name	Using DR and ER		
		D-Sub 9-pin	D-Sub 25-pin		D-Sub 9-pin	D-Sub 25-pin	
FG	-		1	FG	-	1	
RD (RXD)	2	2	3	RD (RXD)	2	3	
SD (TXD)	3	3	2	SD (TXD)	3	2	
ER (DTR)	4		4	ER (DTR)	4	20	
SG (GND)	5	5	7	SG (GND)	5	7	
DR (DSR)	6	8	5	DR (DSR)	6	6	

\*1 For third-party external equipment requiring the control signal, connect these pins.  
The FX5-232-BD, FX5-232ADP does not require these pins to be connected.

## Connection diagram for RS-485

### One-pair wiring

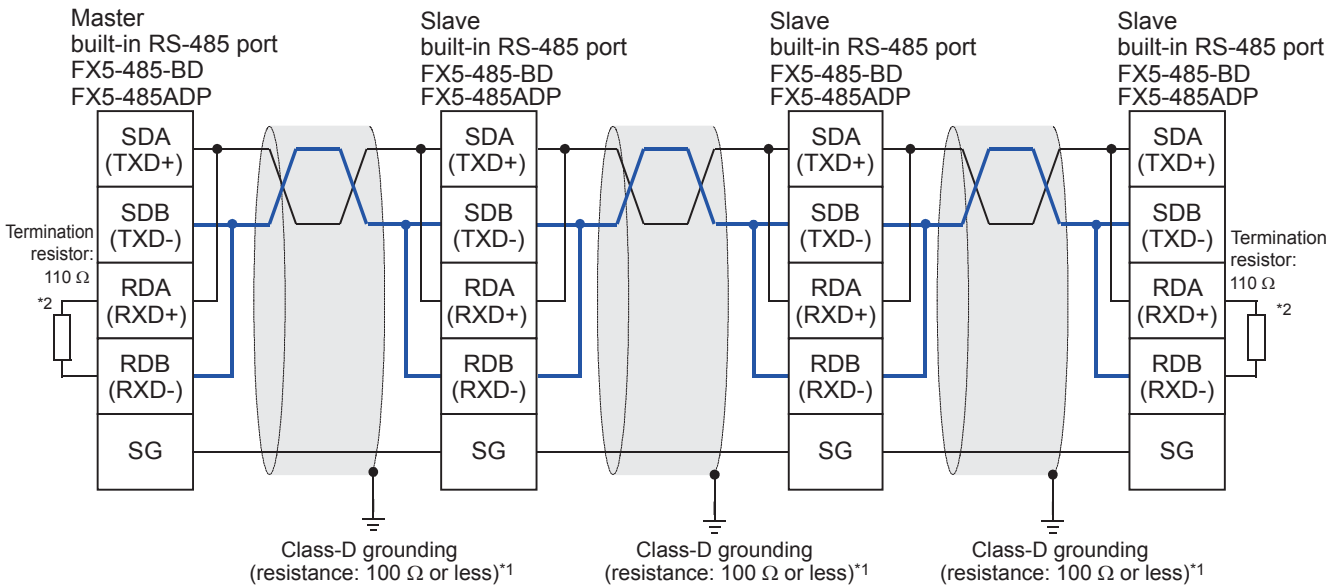

\*1 Make sure to perform Class-D grounding on the shield of the twisted pair cable to be connected.  
\*2 Make sure to provide a termination resistor at each end of a line. Set the selector switch to 110 Ω when the termination resistor is built in.

## Two-pair wiring

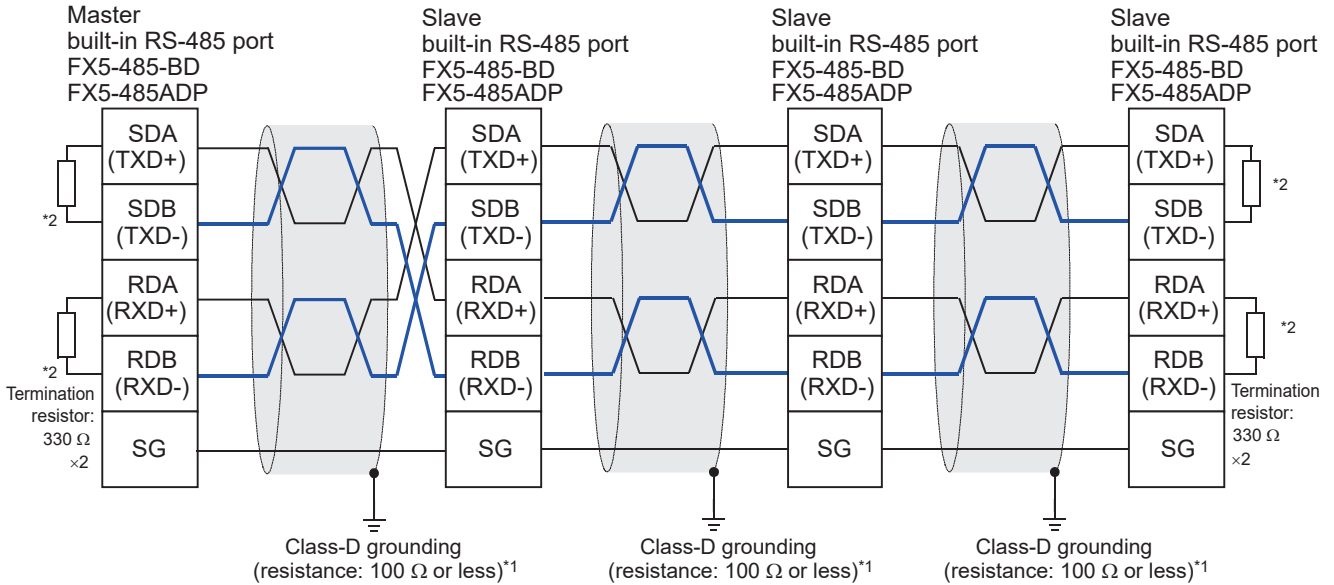

\*1 Make sure to perform Class-D grounding on the shield of the twisted pair cable to be connected.

\*2 Make sure to provide a termination resistor at each end of a line. Set the selector switch to 330 Ω when the termination resistor is built in.

## 5.4 Grounding

Grounding should be performed as stated below.

- The grounding should be class D and the resistance should be 100 Ω or less.
- Independent grounding should be performed for best results. When independent grounding cannot be performed, perform "shared grounding" as shown in the following figure

For details, refer to User's Manual (Hardware) of the CPU module used.

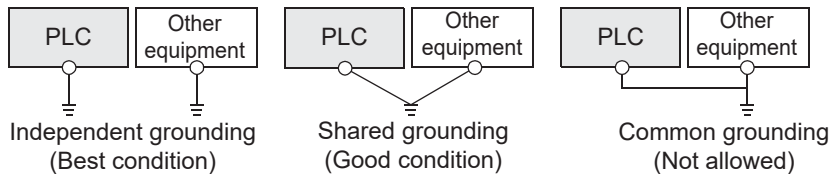

- The grounding wire size should be AWG 14 (2 mm<sup>2</sup>) or larger.
- The grounding point should be close to the PLC, and all grounding wires should be as short as possible.

# 6 COMMUNICATION SETTING

This chapter explains the setup method for using MODBUS serial communication with an FX5.

## 6.1 Setup Method for MODBUS Serial Communication

For the MODBUS serial communication setting of the FX5, set parameters with GX Works3. Setting of parameter differs according to the module used. The procedure for each module is as follows.

### Using the CPU module

"Navigation window" ⇒ [Parameter] ⇒ [FX5UCPU] ⇒ [Module Parameter] ⇒ [485 Serial Port]

#### Window

The following screen will be displayed if "MODBUS\_RTU Communication" is set for Communication Protocol Type.

#### Basic Settings

Item	Setting
<b>Communication Protocol Type</b>	<b>Set communication protocol type.</b>
Communication Protocol Type	MODBUS_RTU Communication
<b>Advanced Settings</b>	<b>Set detailed setting.</b>
Parity Bit	None
Stop Bit	1bit
Baud Rate	115,200bps

Item	Setting	Corresponding station
Communication Protocol Type	When using this function, select "MODBUS_RTU Communication".	Master/Slave
Parity Bit	None, Odd, Even	Master/Slave
Stop Bit	1bit, 2bit	Master/Slave
Baud Rate	300bps, 600bps, 1200bps, 2400bps, 4800bps, 9600bps, 19200bps, 38400bps, 57600bps, 115200bps	Master/Slave

#### Fixed Setting

Item	Setting
<b>Host Station No.</b>	<b>Set host station No.</b>
Host Station No.	0
<b>Slave Response Timeout</b>	<b>Set the slave response timeout.</b>
Slave Response Timeout	3000 ms
<b>Broadcast Delay</b>	<b>Set the broadcast delay.</b>
Broadcast Delay	400 ms
<b>Message to Message Delay</b>	<b>Set the message to message delay.</b>
Message to Message Delay	1 ms
<b>Timeout Retry Count Setting</b>	<b>Set the timeout retry counts.</b>
Timeout Retry Count Setting	5 Times

Item	Setting	Corresponding station
Host Station No.*1	0 to 247 (Master station: 0, Slave station: 1 to 247)	Master/Slave
Slave Response Timeout	1 to 32767 ms	Master/Slave
Broadcast Delay*2	1 to 32767 ms	Master/Slave
Message to Message Delay	1 to 16382 ms	Master/Slave
Timeout Retry Count Setting	0 to 20 Times	Master/Slave

\*1 When set to "Latch" by SM/SD Setting, setting values of the Host Station No. can be changed through special registers. (Page 31 Latch Setting) When other than 0 is set for the special register of a channel that is already set as a master station (station number: 0) by parameter, the channel does not function as a slave station. In addition, when 0 is set for the special register of a channel that is already set as a slave station (station number: 1 to 247) by parameter, the channel does not function as a master station.

\*2 Set master station side broadcast delay as equal to one or more scan times of the slave station.

## ■MODBUS Device Assignment

Item	Setting
<input type="checkbox"/> <b>MODBUS Device Assignment</b> Device Assignment	<b>Set the MODBUS device assignment.</b> <a href="#">&lt;Detailed Setting&gt;</a>

Item	Setting	Corresponding station
Device Assignment	Page 29	Slave

## ■SM/SD Setting

Item	Setting
<input type="checkbox"/> <b>Latch Setting</b> Advanced Settings Host Station No. Slave Response Timeout Broadcast Delay Message to Message Delay Timeout Retry Count Setting	<b>Set the latch of SM/SD device.</b> Do Not Latch Do Not Latch Do Not Latch Do Not Latch Do Not Latch Do Not Latch
<input type="checkbox"/> <b>FX3 Series Compatibility</b> SM/SD for Compatible	<b>The SM/SD device of FX3 series compatibility.</b> Disable

Item	Setting	Corresponding station
Advanced Settings	Do Not Latch	—
Host Station No.	Do Not Latch, Latch	Master/Slave
Slave Response Timeout	Do Not Latch	—
Broadcast Delay	Do Not Latch	—
Message to Message Delay	Do Not Latch	—
Timeout Retry Count Setting	Do Not Latch	—
SM/SD for Compatible	Disable, CH1, CH2 ( Page 31)	Master/Slave

For Latch Setting, refer to Page 31 Latch Setting.

## Using an Extended board

"Navigation window" ⇒ [Parameter] ⇒ [FX5UJCPU] or [FX5UCPU] ⇒ [Module Parameter] ⇒ [Extended Board]

### Window

The following screen will be displayed, if Extended Board to be used is set up and "MODBUS\_RTU Communication" is set Communication Protocol Type.

### ■Basic Settings

Item	Setting
<input type="checkbox"/> <b>Extended Board</b> Extended Board	<b>Set the extended board type.</b> FX5-232-BD
<input type="checkbox"/> <b>Communication Protocol Type</b> Communication Protocol Type	<b>Set communication protocol type.</b> MODBUS_RTU Communication
<input type="checkbox"/> <b>Advanced Settings</b> Parity Bit Stop Bit Baud Rate	<b>Set detailed setting.</b> None 1bit 115,200bps

Item	Setting	Corresponding station
Extended Board	When using this function, select "FX5-232-BD" or "FX5-485-BD".	Master/Slave
Communication Protocol Type	When using this function, select "MODBUS_RTU Communication".	Master/Slave

All screens and setting fields other than extended board are the same as "Using the CPU module". ( Page 27)

# Using an Expansion adapter

When an expansion adapter is used, add expansion adapter to Module Information.

☞ "Navigation window" ⇒ [Parameter] ⇒ [Module Information] ⇒ "Right-click" ⇒ [Add New Module]

After adding the expansion adapter, make settings on the screen displayed from the following operation.

☞ "Navigation window" ⇒ [Parameter] ⇒ [Module Information] ⇒ [ADP1 to ADP6] ⇒ [Module Parameter]

## Window

Each setting screen is the same as "Using the CPU module". (☞ Page 27)

# Contents of parameter setting

The MODBUS device allocation, Latch Setting, SM/SD storage area specification which are used for parameter setting of MODBUS serial communication are as follows.

## MODBUS device allocation

In the MODBUS device allocation, initial values are set for parameters. (Refer to ☞ Page 75 FX5 dedicated pattern)

Parameter contents can be changed with following screen of GX Works3.

## Window

☞ <Detailed Setting> of "MODBUS Device Assignment" (☞ Page 28) is double-clicked.

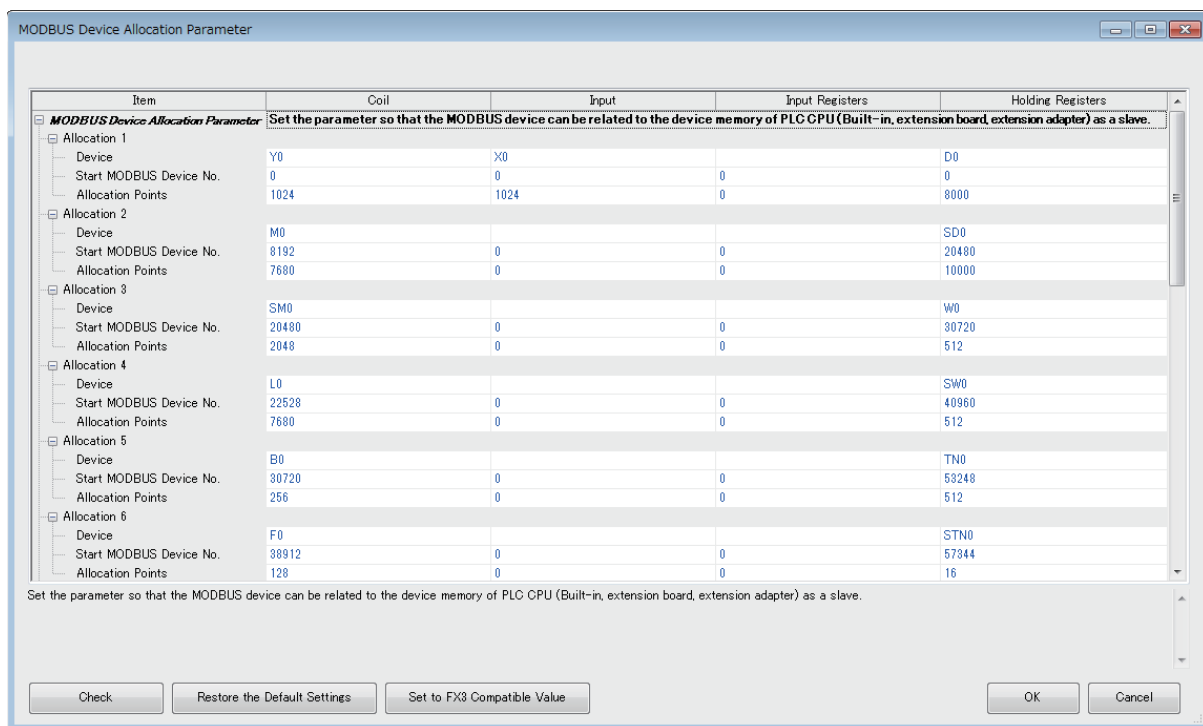

Setting item	Description
Allocation 1 to 16	Allocation of each MODBUS device can be set to 1 to 16.
Device	Set the device type and head number of the device to be allocated. (For available devices, refer to ☞ Page 30 Available devices)
Start MODBUS Device No.	Set the start MODBUS device number.
Allocation Points	Set the number of allocation points.

## Available devices

The following table shows devices that can be set to coil, input, input register, and holding register.

List of devices		Allocable MODBUS device				
Device type	Device	Coil	Input	Input register	Holding register	
Special relay	SM	○	○	○*1	○*1	
Special register	SD	—	—	○	○	
Input	X	○	○	○*1	○*1	
Output	Y	○	○	○*1	○*1	
Internal relay	M	○	○	○*1	○*1	
Latch relay	L	○	○	○*1	○*1	
Annunciator	F	○	○	○*1	○*1	
Link relay	B	○	○	○*1	○*1	
Data register	D	—	—	○	○	
Link register	W	—	—	○	○	
Timer	Coil	TC	○	○	○*1	○*1
	Contact	TS	○	○	○*1	○*1
	Current value	TN	—	—	○	○
Retentive timer	Coil	STC	○	○	○*1	○*1
	Contact	STS	○	○	○*1	○*1
	Current value	STN	—	—	○	○
Counter	Coil	CC	○	○	○*1	○*1
	Contact	CS	○	○	○*1	○*1
	Current value	CN	—	—	○	○
Long counter	Coil	LCC	○	○	○*1	○*1
	Contact	LCS	○	○	○*1	○*1
	Current value	LCN	—	—	○*2	○*2
Link special relay	SB	○	○	○*1	○*1	
Link special register	SW	—	—	○	○	
Step relay	S	○	○	○*1	○*1	
Index register	Z	—	—	○	○	
Index register	LZ	—	—	○*2	○*2	
File register	R	—	—	○	○	
Extended file register	ER	—	—	—	—	

\*1 Set the device number and the allocating points in multiples of 16. In the case that the number of points is not a multiple of 16, a parameter setting error occurs in GX Works3.

\*2 Because MODBUS devices are long type devices, 2 points are allocated.

## Precautions

- The same device cannot be set for a coil and an input.
- The same device cannot be set for an input register and a holding register.
- A parameter setting error occurs in GX Works3 when the total of selected head device number and the allocated points exceed the valid range for the selected PLC device.



## Latch Setting

In latch setting, it can be set up whether the host number should operate using the GX Works3 parameter or special register.

- In the case of "Do Not Latch", the host number operates using the value set by the parameter setting of GX Works3.
- In the case of "Latch", special relays corresponding to each CH turn on and the host number operates using the value set by special registers. Value of special registers can be changed by program. The following table shows, special relays and special registers corresponding for each channel.

CH	Special relays	Special registers	Corresponding parameter
CH1	SM8861	SD8861	Host station number setting
CH2	SM8871	SD8871	
CH3	SM8881	SD8881	
CH4	SM8891	SD8891	

### Point

Setting value of special registers or parameter are reflected when the power supply is turned from off to on or reset.

## Precautions

When the SD latch setting valid information is set to off due to memory clear and so on, while special registers are set to "Latch" by the parameter, the parameter setting becomes valid when the power is turned off to on or reset.

## SM/SD for FX3 Series compatible

In the FX5, special relays of the FX3 and special registers of the FX3 can be used in the compatibility area.

Channel numbers may differ between the FX3 and the FX5 depending on the configuration. Select whether to use special devices for the corresponding channel number (CH1 or CH2) in this setting.

- When this setting is not configured, SM and SD for FX3 series compatibility are not used.
- When this setting is configured, select CH1 or CH2 SM and SD for FX3 series compatibility.

For the device for FX3 series compatible, refer to the following.

 Page 35 Related Devices

# 7 FUNCTION

This chapter explains the function of MODBUS serial communication.

## 7.1 Master Function

In the FX5 master function, communication is executed with the slave station using the ADPRW instruction.

### ADPRW

This instruction allows to communicate (read/write data) with the slave station by the function code which is supported by the master.

Ladder diagram	Structured text
	<pre>ENO:=ADPRW(EN,s1,s2,s3,s4,s5d1,d2);</pre>

### FBD/LD

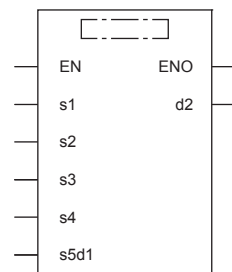

### Setting data

#### ■ Descriptions, ranges, data types

Operand	Description	Range	Data type	Data type (label)
(s1)	Slave station No.	0 to F7H <sup>*1</sup>	16-bit signed binary	ANY16
(s2)	Function code (Refer to  Page 33)	01H to 06H, 0FH, 10H	16-bit signed binary	ANY16
(s3)	Function parameter depending on the function code (Refer to  Page 33)	0 to FFFFH	16-bit signed binary	ANY16
(s4)	Function parameter depending on the function code (Refer to  Page 33)	1 to 2000	16-bit signed binary	ANY16
(s5)/(d1)	Function parameter depending on the function code (Refer to  Page 33)	—	Bit/16-bit signed binary	ANY_ELEMENTARY
(d2) <sup>*2</sup>	Start bit device number to which communication execution status is output	—	Bit	ANYBIT_ARRAY (Number of elements: 3)
EN	Execution condition	—	Bit	BOOL
ENO	Execution result	—	Bit	BOOL

\*1 Slave station No. that can be used in FX5 master station differs depending on the version. ( Page 77 Added and Enhanced Functions)

\*2 Three devices are occupied from the device specified in (d2). Make sure that these devices are not used in other controls.

## Available devices

Operand	Bit	Word			Double word		Indirect specification	Constant			Others
	X, Y, M, L, SM, F, B, SB	T, ST, C, D, W, SD, SW, R	U□\G□	Z	LC	LZ		K, H	E	\$	
(s1)	—	○*1	○	○	—	—	○	○	—	—	—
(s2)	—	○*1	○	○	—	—	○	○	—	—	—
(s3)	—	○*1	○	○	—	—	○	○	—	—	—
(s4)	—	○*1	○	○	—	—	○	○	—	—	—
(s5)/(d1)	○	○*1	○	○	—	—	○	○	—	—	—
(d2)	○	○*1	—	—	—	—	—	—	—	—	—

\*1 T, ST, C cannot be used.

## Processing details

- Function code (s2) is operated on slave station No. (s1) according to parameters (s3), (s4), and (s5)/(d1). Use 0 as the slave station No. (s1) for broadcast commands. (Refer to Page 33 Function code and function parameters.)
- The communication execution status (d2) is output according to each status of the ADPRW instruction such as communicating/completed normally/completed with an error. (Refer to Page 34 Communication execution status output device.)

## Function code and function parameters

The following table shows the parameter allocation of (s3), (s4), and (s5)/(d1) for each function code (s2).

(s2): Function code	(s3): MODBUS address	(s4): Device count	(s5)/(d1): Start device storing data	
	Applicable device: ② (Refer to the following applicable devices.)			Applicable device
01H Read coils	MODBUS address: 0000H to FFFFH	Device count: 1 to 2000	Start device storing read data	
			Applicable device	Word device ① (Refer to the following table of the applicable devices.) Bit device ③ (Refer to the following table of the applicable devices.)
			Number of occupied points	Word device $((s4) + 15) \div 16$ points*1 Bit device (s4) points
02H Read inputs	MODBUS address: 0000H to FFFFH	Device count: 1 to 2000	Start device storing read data	
			Applicable device	Word device ① (Refer to the following table of the applicable devices.) Bit device ③ (Refer to the following table of the applicable devices.)
			Occupied points	Word device $((s4) + 15) \div 16$ points*1 Bit device (s4) points
03H Read holding registers	MODBUS address: 0000H to FFFFH	Device count: 1 to 125	Start device storing read data	
			Applicable device	① (Refer to the following table of the applicable devices.)
			Occupied points	(s4) points
04H Read input registers	MODBUS address: 0000H to FFFFH	Device count: 1 to 125	Start device storing read data	
			Applicable device	① (Refer to the following table of the applicable devices.)
			Occupied points	(s4) points
05H Write coils	MODBUS address: 0000H to FFFFH	0 (fixed)	Start device storing write data	
			Applicable device*2	Word device ② (Refer to the following table of the applicable devices.) Bit device ③ (Refer to the following table of the applicable devices.)
			Occupied points	1 point
06H Write holding registers	MODBUS address: 0000H to FFFFH	0 (fixed)	Start device storing write data	
			Applicable device	② (Refer to the following table of the applicable devices.)
			Occupied points	1 point

(s2): Function code	(s3): MODBUS address	(s4): Device count	(s5)/(d1): Start device storing data	
	Applicable device: ❷ (Refer to the following applicable devices.)			
0FH Write multiple coils	MODBUS address: 0000H to FFFFH	Device count: 1 to 1968	Start device storing write data	
			Applicable device	Word device ❷ (Refer to the following table of the applicable devices.) Bit device ❸ (Refer to the following table of the applicable devices.)
			Occupied points	Word device $((s4) + 15) \div 16$ points* <sup>1</sup> Bit device (s4) points
10H Write multiple holding registers	MODBUS address: 0000H to FFFFH	Device count: 1 to 123	Start device storing write data	
			Applicable device	❷ (Refer to the following table of the applicable devices.)
			Occupied points	(s4) points

\*1 Fractions are rounded off.

\*2 When the least significant bit is 0, the bit is off. When the least significant bit is 1, the bit is on.

#### ► Applicable device table

No.	Applicable device
❶	T, ST, C, D, R, W, SW, SD, label device
❷	T, ST, C, D, R, W, SW, SD, label device, K, H
❸	X, Y, M, L, B, F, SB, S, SM, label device

### ■ Communication execution status output device

The following shows the timing of operation of the communication execution status output device (d2) according to each communication status, and the special relays which operate at the same time.

Operand	Timing of operation	Special relay which operates at the same time
(d2)	Turns on while the instruction is executed and turns off in the status other than while the instruction is executed.	SM8800 (CH1), SM8810 (CH2), SM8820 (CH3), SM8830 (CH4)* <sup>1</sup>
(d2) + 1* <sup>2</sup>	Turns on when the instruction is completed normally and turns off when the communication is started.	—
(d2) + 2* <sup>2</sup>	Turns on when the instruction is completed with an error and turns off when the communication is started.	—

\*1 SM8401 (CH1) or SM8421 (CH2) turn on, when SM/SD for FX3 series compatible is set.

\*2 (d2) + 1 turns on when the instruction is completed normally and (d2) + 2 turns on when the instruction is completed with an error, so that whether the instruction is completed normally or with an error can be judged.

### Precautions

- The channel which uses the ADPRW instruction must be set to the master station by the GX Works3. (☞ Page 27 Fixed Setting) When it is not set, the device does not operate even though the ADPRW instruction is executed. (Also no error occurs.)
- If the program stops due to error, the device value is turned off if a non-latch device is designated as the communication execution status output device. Specify a latch device to keep the communication state output.

## 7.2 Slave Function

This function performs operations according to the supported function code by communication with the master station. For the supported function codes, refer to  Page 21 List of supported MODBUS standard functions.

## 7.3 Related Devices

In this section, the functions of the special relays and special registers are described for MODBUS serial communication.

### Point

Available communication channels differs depending on the CPU module and system configuration.

For the communication channel, refer to  Page 14 System Configuration.

The devices of "For FX3 compatibility" operate in the channel which is specified by the SM/SD for compatibility in communication setting.

For the "SM/SD for Compatible", refer to  Page 27 COMMUNICATION SETTING.

## List of related devices

### Special relays

The table shows the special relays used for the FX5 MODBUS serial communication.

#### ■ Only for FX5

Device number				Name	Valid	Details	R/W
CH1	CH2	CH3	CH4				
SM8500	SM8510	SM8520	SM8530	Serial communication error	Master/Slave	Turns on when an error occurs during the serial communication.	R
SM8800	SM8810	SM8820	SM8830	During MODBUS serial communication	Master	Turns on when the instruction is started until the instruction execution complete flag is turned on during MODBUS serial communication.	R
SM8801	SM8811	SM8821	SM8831	Retry	Master	Turns on while the master sends retries when the slave fails to respond until timeout setting time.	R
SM8802	SM8812	SM8822	SM8832	Timeout	Master	Turns on if a response timeout occurs.	R
SM8861	SM8871	SM8881	SM8891	Host station number latch setting valid	Slave	Turns on when the latch setting is set to "Latch".	*1

R: Read only, R/W: Read/Write

\*1 The devices become R/W when a latch is set and R when a latch is not set.

#### ■ For FX3 series compatibility

Device number		Name	Valid	Details	R/W
CH1	CH2				
SM8029		Instruction execution complete	Master	Turns on if the processing of an instruction is completed.	R
SM8401	SM8421	During MODBUS communication	Master	Turns on when the instruction is started until the instruction execution complete flag is turned on during MODBUS serial communication.	R
SM8402	SM8422	MODBUS communication error	Master	Turns on when an error occurs during MODBUS serial communication.	R
SM8403	SM8423	MODBUS communication error (latched)	Master/Slave	Turns on once an error occurs during MODBUS serial communication.	R
SM8063	SM8438	Serial communication error	Master/Slave	Turns on once an error occurs during MODBUS serial communication.	R
SM8408	SM8428	Retry	Master	Turns on while the master sends retries when the slave fails to respond until timeout setting time.	R
SM8409	SM8429	Timeout	Master	Turns on if a response timeout occurs.	R

R: Read only

## Special registers

The table shows the special registers used for the FX5 MODBUS serial communication.

### ■ Only for FX5

Device number				Name	Valid	Details	R/W
CH1	CH2	CH3	CH4				
SD8500	SD8510	SD8520	SD8530	Serial communication error code	Master/ Slave	Stores the current error code generated during serial communication.	R
SD8501	SD8511	SD8521	SD8531	Serial communication error details	Master/ Slave	Stores current error details.	R
SD8502	SD8512	SD8522	SD8532	Serial communication setting	Master/ Slave	Stores the communication properties in the CPU module.	R
SD8503	SD8513	SD8523	SD8533	Serial communication operation mode	Master/ Slave	Stores the mode of serial communication being executed.	R
SD8800	SD8810	SD8820	SD8830	Current retry value	Master/ Slave	Stores the current value of retries of when a communication retry is executed due to slave response timeout.	R
SD8861	SD8871	SD8881	SD8891	Host station number	Master/ Slave	Stores the host station number setting value.	*1
SD8862	SD8872	SD8882	SD8892	Slave response timeout	Master/ Slave	Stores the slave response timeout setting value.	R
SD8863	SD8873	SD8883	SD8893	Broadcast delay	Master/ Slave	Stores the broadcast delay setting value.	R
SD8864	SD8874	SD8884	SD8894	Message to message delay	Master/ Slave	Stores the message to message delay setting value.	R
SD8865	SD8875	SD8885	SD8895	Timeout retry count	Master/ Slave	Stores the timeout retry count setting value.	R

R: Read, R/W: Read/Write

\*1 The devices vary depending on the Latch Setting. The device becomes R when the Latch setting is "Do not Latch", and R/W when the Latch setting is "Latch".

### ■ For FX3 series compatibility

Device number		Name	Valid	Details	R/W
CH1	CH2				
SD8063	SD8438	Serial communication error code	Master/ Slave	Stores the current error code generated during serial communication.	R
SD8402	SD8422	Communication error code	Master/ Slave	Stores the current error code generated during serial communication.	R
SD8403	SD8423	Error details	Master/ Slave	Stores the current error details.	R
SD8405	SD8425	Communication format setting value	Master/ Slave	Stores the communication parameter set in the CPU module.	R
SD8408	SD8428	Current retry value	Master/ Slave	Stores the current value of retries of when a communication retry is executed due to slave response timeout.	R
SD8419	SD8439	Communication operation mode	Master/ Slave	Stores the communication operation mode in the CPU module.	R

R: Read

## Details of Related Devices

### Instruction execution complete

This device checks whether the execution of the instruction is completed.

Only for FX5				For FX3 series compatibility		Description	R/W
CH1	CH2	CH3	CH4	CH1	CH2		
SM8029						Turns on if the processing of the instruction is completed.	R

R: Read



SM8029 is also used as the execution completed flag for other instructions (such as positioning instructions). When using SM8029, provide the contact just under the instruction whose execution completion is to be checked.

### Precautions

Do not turn ON with program or engineering tool.

This device does not turn OFF even if normal communication is restored. The device is cleared when the power supply is turned from off to on, reset, set from STOP to RUN, or the next ADPRW instruction is executed.

### During MODBUS communication

This device checks if MODBUS serial communication is being executed.

Only for FX5				For FX3 series compatibility		Description	R/W
CH1	CH2	CH3	CH4	CH1	CH2		
SM8800	SM8810	SM8820	SM8830	SM8401	SM8421	Turns on when the instruction is started until the instruction execution complete flag is turned on during MODBUS serial communication.	R

R: Read

### Precautions

Do not turn ON with program or engineering tool.

The device is cleared when the power supply is turned from off to on, reset, or set from STOP to RUN.

### MODBUS communication error

This device checks if an error occurs during MODBUS serial communication.

For FX3 series compatibility		Description	R/W
CH1	CH2		
SM8402	SM8422	Turns on when an error occurs during MODBUS serial communication.	R

R: Read

### Precautions

Do not turn ON with program or engineering tool.

This device does not turn OFF even if normal communication is restored. The device is cleared when the power supply is turned from off to on, reset, set from STOP to RUN, SM50 (Error Detection Reset Completion) is turned on, or the next ADPRW instruction is executed.

## MODBUS communication error (latched)

This device checks if an error occurs during MODBUS serial communication.

For FX3 series compatibility		Description	R/W
CH1	CH2		
SM8403	SM8423	Turns on once an error occurs during MODBUS serial communication.	R

R: Read

### Precautions

Do not turn ON with program or engineering tool.

The device is cleared when the power supply is turned from off to on, reset, or set from STOP to RUN.

## Serial communication error

This device checks if an error occurs during serial communication.

Only for FX5				For FX3 series compatibility		Description	R/W
CH1	CH2	CH3	CH4	CH1	CH2		
SM8500	SM8510	SM8520	SM8530	SM8063	SM8438	Turns on when an error occurs during serial communication.	R

R: Read

### Precautions

Do not turn ON with program or engineering tool.

This device do not turn OFF even if normal communication is restored. The device is cleared when the power supply is turned from off to on, reset, set from STOP to RUN, or SM50 (Error Detection Reset Completion) is turned on.

## Retry

This device checks if a retry occurs during MODBUS serial communication.

Only for FX5				For FX3 series compatibility		Description	R/W
CH1	CH2	CH3	CH4	CH1	CH2		
SM8801	SM8811	SM8821	SM8831	SM8408	SM8428	Turns on while the master sends retries when the slave fails to respond in time.	R

R: Read

### Precautions

Do not turn ON with program or engineering tool.

The device is cleared when the power supply is turned from off to on, reset, set from STOP to RUN, SM50 (Error Detection Reset Completion) is turned on, or the next ADPRW instruction is executed.



## Timeout

This device checks if a timeout occurs during MODBUS serial communication.

Only for FX5				For FX3 series compatibility		Description	R/W
CH1	CH2	CH3	CH4	CH1	CH2		
SM8802	SM8812	SM8822	SM8832	SM8409	SM8429	Turns on if a response timeout occurs.	R

R: Read

### Precautions

Do not turn ON with program or engineering tool.

The device is cleared when the power supply is turned from off to on, reset, set from STOP to RUN, SM50 (Error Detection Reset Completion) is turned on, or the next ADPRW instruction is executed.

If the number of retries is 1 or more, the error flag (📖 Page 60 Error flags) is not set until the set number of retries fail by timeout (or another failure).

## Host station number SD latch setting valid

The device which set latch valid/invalid of host station number for MODBUS serial communication.

Only for FX5				Description	R/W
CH1	CH2	CH3	CH4		
SM8861	SM8871	SM8881	SM8891	Turns on when host station number setting is "Latch" in MODBUS communication parameter.	*1

R: Read, R/W: Read/Write

\*1 The devices vary depending on the Latch Setting. The device becomes R when the Latch setting is "Do not Latch", and R/W when the Latch setting is "Latch".

### Precautions

Do not turn ON with program or engineering tool.

The device is set when the power supply is turned from off to on or reset.

## Serial communication error code

This device stores the current error codes during serial communication. (📖 Page 60 Error code.)

Only for FX5				For FX3 series compatibility		Description	R/W
CH1	CH2	CH3	CH4	CH1	CH2		
SD8500	SD8510	SD8520	SD8530	SD8402 SD8063	SD8422 SD8438	Stores the current error code generated by serial communication.	R

R: Read

### Precautions

Do not change the device value using a program or an engineering tool.

The device is cleared when the power supply is turned from off to on, reset, set from STOP to RUN, or SM50 (Error Detection Reset Completion) is turned on, only in the master.

## Serial communication error details

This device stores the current error details during serial communication. (📖 Page 60 Error code.)

Only for FX5				For FX3 series compatibility		Description	R/W
CH1	CH2	CH3	CH4	CH1	CH2		
SD8501	SD8511	SD8521	SD8531	SD8403	SD8423	Stores the current error details generated during serial communication.	R

R: Read

### Precautions

Do not change the device value using a program or an engineering tool.

The device is cleared when the power supply is turned from off to on, reset, set from STOP to RUN, or SM50 (Error Detection Reset Completion) is turned on, only in the master.

## Communication format setting value

This device stores the communication format setting value.

Only for FX5				For FX3 series compatibility		Description	R/W
CH1	CH2	CH3	CH4	CH1	CH2		
SD8502	SD8512	SD8522	SD8532	SD8405	SD8425	Stores the parameters set by an engineering tool. For details, refer to the following table.	R

R: Read

The following table shows the parameter descriptions of the communication format.

Bit	Name	Description	
		0 (bit = OFF)	1 (bit = ON)
b0	—	—	—
b1, b2	Parity bit	(b2, b1) = (0, 0): None (b2, b1) = (0, 1): Odd (b2, b1) = (1, 1): Even	
b3	Stop bit	1bit	2bit
b4 to b7	Baud rate (bps)	(b7, b6, b5, b4) = (0, 0, 1, 1): 300 (b7, b6, b5, b4) = (0, 1, 0, 0): 600 (b7, b6, b5, b4) = (0, 1, 0, 1): 1200 (b7, b6, b5, b4) = (0, 1, 1, 0): 2400 (b7, b6, b5, b4) = (0, 1, 1, 1): 4800 (b7, b6, b5, b4) = (1, 0, 0, 0): 9600 (b7, b6, b5, b4) = (1, 0, 0, 1): 19200 (b7, b6, b5, b4) = (1, 0, 1, 0): 38400 (b7, b6, b5, b4) = (1, 0, 1, 1): 57600 (b7, b6, b5, b4) = (1, 1, 0, 1): 115200	
b8 to b15	—	—	—

### Precautions

Do not change the device value using a program or an engineering tool.

The setting value changes when the power supply is turned from off to on or reset.

## Operation mode display

This device stores the operation mode of the serial communication being executed.

Only for FX5				For FX3 series compatibility		Description	R/W
CH1	CH2	CH3	CH4	CH1	CH2		
SD8503	SD8513	SD8523	SD8533	SD8419	SD8439	0: MELSOFT Connection or MC protocol 3: N:N Network Communication 5: Non-protocol Communication 6: Parallel Link Communication 7: Inverter Communication 9: MODBUS RTU Communication 12: Predefined protocol support Other than above: Not used	R

R: Read

### Precautions

Do not change the device value using a program or an engineering tool.  
The device is cleared when ADPRW instruction is executed.

## Current retry value

This device stores the current retry value.

Only for FX5				For FX3 series compatibility		Description	R/W
CH1	CH2	CH3	CH4	CH1	CH2		
SD8800	SD8810	SD8820	SD8830	SD8408	SD8428	Stores the current value of retries executed by the slave response timeout.	R

R: Read

### Precautions

Do not change the device value using a program or an engineering tool.  
The device is cleared when the power supply is turned from off to on, reset, set from STOP to RUN, SM50 (Error Detection Reset Completion) is turned on, or next ADPRW instruction is executed.

## Host station number

This device stores the host station number setting value.

Only for FX5				Description	R/W
CH1	CH2	CH3	CH4		
SD8861	SD8871	SD8881	SD8891	Stores the parameters (host station number) set by a program or an engineering tool. For 0: Master station For 1 to 247: Slave station (station number: 1 to 247)	*1

R: Read, R/W: Read/Write

\*1 The devices vary depending on the Latch Setting. The device becomes R when the Latch setting is "Do not Latch", and R/W when the Latch setting is "Latch".

### Precautions

#### ■ "Latch"

The device value can be changed by the program.

#### ■ "Do Not latch"

Do not change the device value using a program or an engineering tool.

#### ■ Change "Do Not Latch" to "Latch"

The setting value is reflected when the power supply is turned from off to on or reset, after parameter write from an engineering tool.

## Slave response timeout

This device stores the slave response timeout setting value.

Only for FX5				Description	R/W
CH1	CH2	CH3	CH4		
SD8862	SD8872	SD8882	SD8892	Stores the parameters (slave response timeout) set by an engineering tool.	R

R: Read

### Precautions

The setting value is reflected when the power supply is turned from off to on, reset, or the next ADPRW instruction is executed.

## Broadcast delay

This device stores the broadcast delay setting value.

Only for FX5				Description	R/W
CH1	CH2	CH3	CH4		
SD8863	SD8873	SD8883	SD8893	Stores the parameters (broadcast delay) set by an engineering tool.	R

R: Read

### Precautions

The setting value is reflected when the power supply is turned from off to on, reset, or the next ADPRW instruction is executed.

## Message to message delay

This device stores the message to message delay setting value.

Only for FX5				Description	R/W
CH1	CH2	CH3	CH4		
SD8864	SD8874	SD8884	SD8894	Stores the parameters (message to message delay) set by an engineering tool.	R

R: Read

### Precautions

The setting value is reflected when the power supply is turned from off to on, reset, or the next ADPRW instruction is executed.

## Timeout retry count

This stores the timeout retry count setting value.

Only for FX5				Description	R/W
CH1	CH2	CH3	CH4		
SD8865	SD8875	SD8885	SD8895	Stores the parameters (timeout retry count) set by an engineering tool.	R

R: Read

### Precautions

The setting value is reflected when the power supply is turned from off to on, reset, or the next ADPRW instruction is executed.

# 8 CREATING PROGRAMS

This chapter explains an example of creating programs for the master in MODBUS serial communication.

## 8.1 Creating Programs for the Master Station

Programs allowing the master station to read and write slave station devices can be created as shown in the example below.

For ADPRW instruction, refer to [Page 32 ADPRW](#).

For cautions on program creation, refer to [Page 44 Cautions on Program Creation](#).

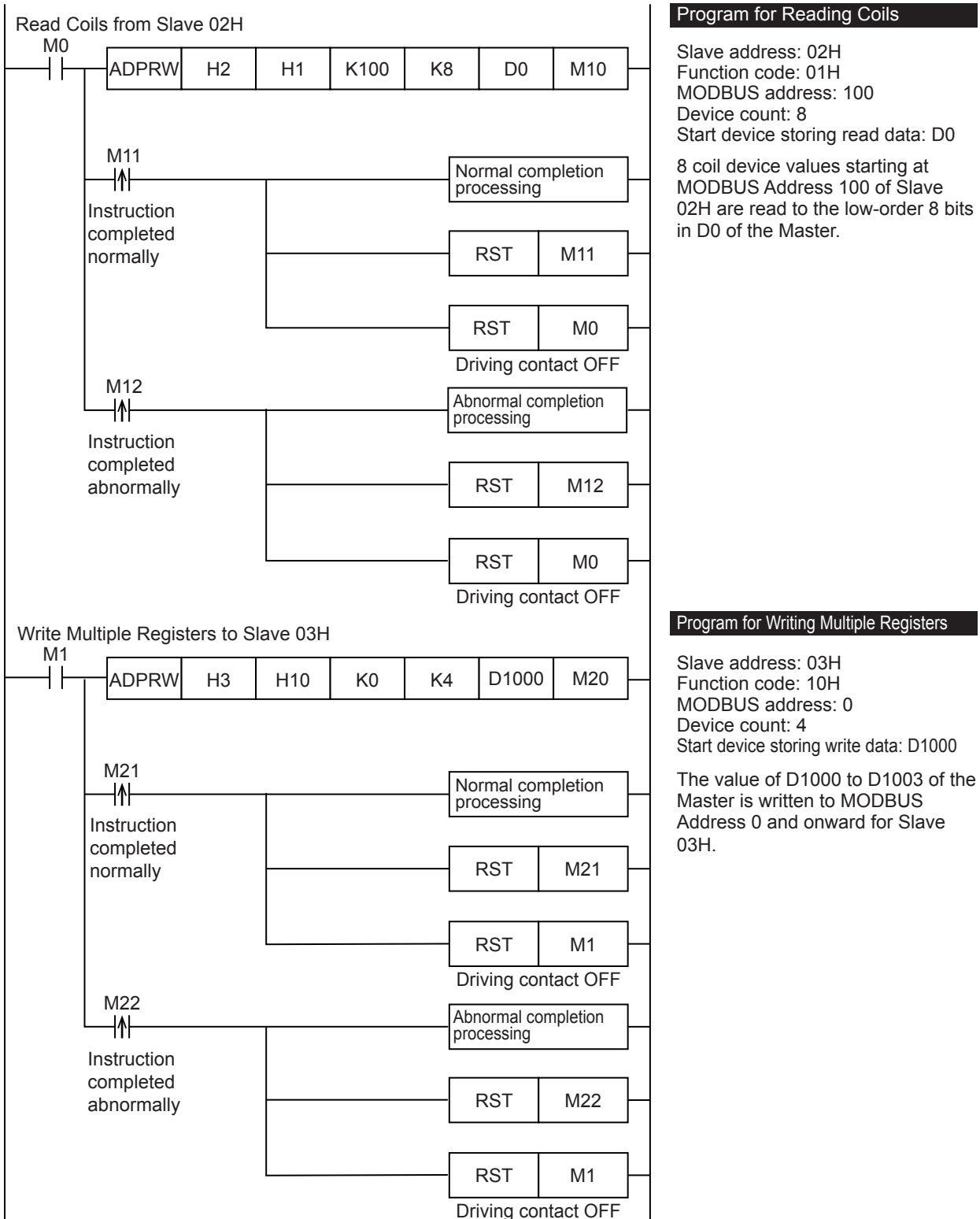

## 8.2 Cautions on Program Creation

---

- Make sure the driving contact of the ADPRW instruction does not turn off until the instruction has been completed.
- For the ADPRW instruction, a start timing of communication differs depending on the condition at the time of driving. When the ADPRW instruction is driven alone, communication is instantaneously started. When multiple ADPRW instructions are simultaneously driven, after communication by the former driven ADPRW instruction is completed, the communication by the latter driven ADPRW instruction is started. Make sure the driving contact of the ADPRW instruction does not turn off until the instruction has been completed.
- When using the Read coils function or Read inputs function in the Master with a word device (i.e. D, or R) as the destination device, only the number of bits assigned in the device count of the ADPRW instruction will be overwritten. The remaining bits of the word device will not be affected.

This part consists of the following chapters.

9 OUTLINE

---

10 SPECIFICATIONS

---

11 MODBUS/TCP COMMUNICATION SPECIFICATIONS

---

12 COMMUNICATION SETTING

---

13 FUNCTION

---

# 9 OUTLINE

This chapter explains the FX5 MODBUS/TCP communication (slave station).

For details of predefined protocol support function, refer to  MELSEC iQ-F FX5 User's Manual (Ethernet Communication).

## 9.1 Outline of Function

The FX5 MODBUS/TCP communication function allows communication, via Ethernet connection, with various MODBUS/TCP master devices which are connected to FX5 set as the slave station.

- The master function and slave function are supported and the master and slave can be used simultaneously by a single FX5.
- Up to 8 connections can be used for MODBUS/TCP communication function by one CPU module.
- The master uses a predefined protocol support function and controls the slave.

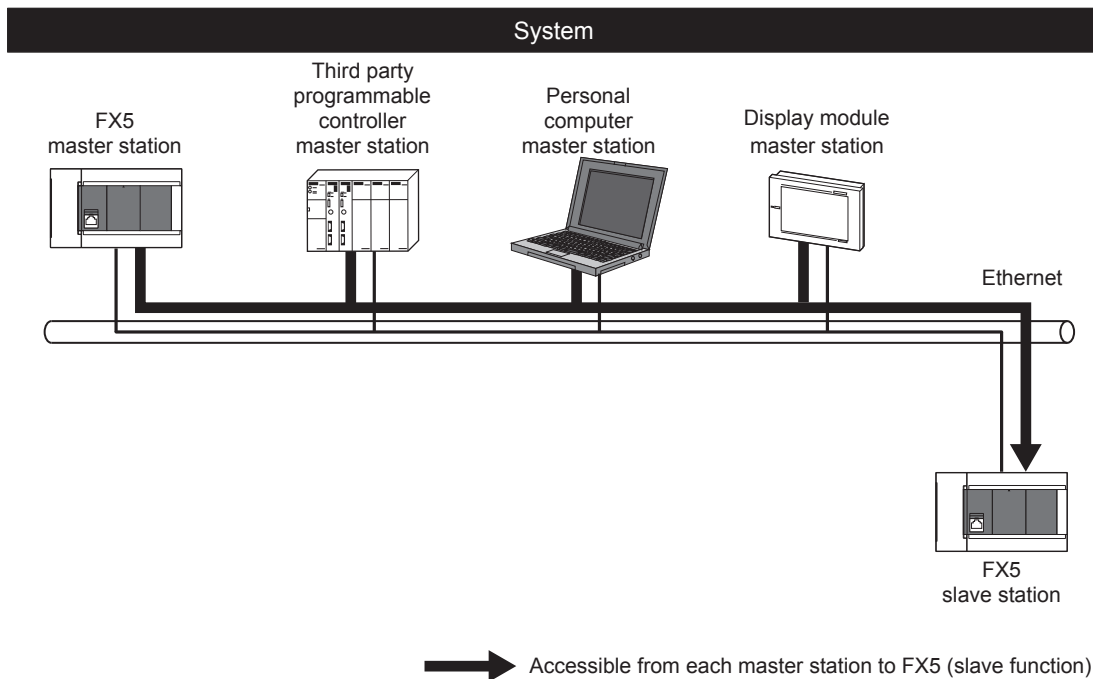

### Point

An external device other than FX5 can be used as the master station and slave station.



## 9.2 Procedure for Operation

The flow chart below shows the procedure for setting up a MODBUS/TCP communication (slave station):

### 1. Check communication specifications

☞ Refer to Page 48 Communication Specifications or Page 50 MODBUS/TCP COMMUNICATION SPECIFICATIONS

- Communication Specifications
- MODBUS Serial Communication Specifications

Details of MODBUS Standard Functions

### 2. Communication settings

☞ Refer to Page 52 COMMUNICATION SETTING

- Communication setting using GX Works3<sup>\*1</sup>

Setting parameters

### 3. Check of function<sup>\*2</sup>

☞ Refer to Page 55 FUNCTION

- Slave function

\*1 For details on the connection method or operation method to the PLC of GX Works3, refer to the following manual.

☞ GX Works3 Operating Manual

\*2 Slave station doesn't need a program.

# 10 SPECIFICATIONS

This chapter explains the specifications of MODBUS/TCP communication.

## 10.1 Communication Specifications

MODBUS/TCP communication is executed within the specifications shown in the table below.

For communication specification other than the followings, refer to  MELSEC iQ-F FX5 User's Manual (Ethernet Communication).

Item		Specification
Protocol type		MODBUS/TCP (Support only the binary)
Number of connections		Total of 8 connections* <sup>1</sup> (Up to 8 external devices can access one CPU module at the same time.)
Slave function	Number of function	10
	Port station No.	502* <sup>2</sup>

\*1 The number of available connections decreases when the other Ethernet communication function is used. For details of Ethernet function, refer to the following manual.

 MELSEC iQ-F FX5 User's Manual (Ethernet Communication)

\*2 The port station No. can be changed by the communication setting.



# 11 MODBUS/TCP COMMUNICATION SPECIFICATIONS

This chapter explains the details of MODBUS Protocol for MODBUS/TCP communication and the MODBUS standard functions supported by the FX5.

- For the list of supported MODBUS standard functions, refer to [Page 50 List of supported MODBUS standard functions](#).
- For usage of the supported MODBUS standard functions, refer to [Page 55 FUNCTION](#).

## 11.1 MODBUS Protocol

### Frame specifications

The following figure illustrates the frame specifications for the MODBUS protocol.

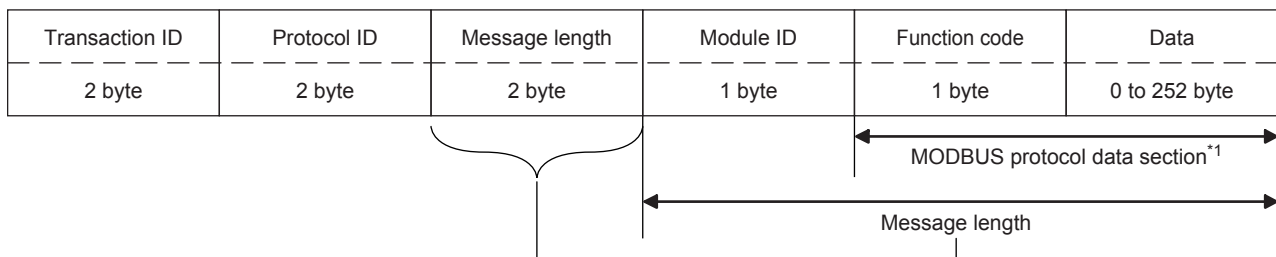

\*1 For details of the MODBUS protocol data section, refer to [Page 65](#).

The following table provides details of the frame specifications for the MODBUS Protocol.

Area name	Description
Transaction ID	Used by the master for matching of the response message from the slave.
Protocol ID	Indicates the protocol of the PDU (protocol data unit). Stores 0 in the case of MODBUS/TCP.
Message length	Stores the message size in byte unit. The message length after this field is stored. (See the above figure.)
Module ID	Used to specify the slave connected to the other line, e.g. MODBUS serial protocol. (FX5 is not supported)
Function code	The master specifies the function code to the slave.
Data	[When the master sends a request message to a slave] Stores the requested processing. [When the slave sends a response message to the master] Stores the result of processing execution.

### List of supported MODBUS standard functions

The following table lists the MODBUS standard functions supported by the MODBUS/TCP communication of FX5.

Function code	Function Name	Details	Accessible devices per message	Reference
01H	Read coils	Read binary (R/W) devices	1 to 2000 points	Page 66
02H	Read inputs	Read binary (RO) devices	1 to 2000 points	Page 67
03H	Read holding registers	Read 16 bit (R/W) registers	1 to 125 points	Page 68
04H	Read input registers	Read 16 bit (RO) registers	1 to 125 points	Page 69
05H	Write single coil	Write single binary device	1 point	Page 70
06H	Write single register	Write single 16 bit register device	1 point	Page 70
0FH	Write multiple coils	Write multiple binary (R/W) devices	1 to 1968 points	Page 71
10H	Write multiple registers	Write multiple 16 bit (R/W) registers	1 to 123 points	Page 72
16H	Mask write register	Manipulate slave register with AND Mask/OR Mask	1 point	Page 73
17H	Read/write multiple registers	Read/write multiple 16 bit (R/W) registers	Read: 1 to 125 points Write: 1 to 121 points	Page 74



# 12 COMMUNICATION SETTING

This chapter explains the setup method for using slave station in MODBUS/TCP communication with an FX5.

## 12.1 Setup Method for Port No.

Set the port No. to identify the communication between the slave station and the master station.

"Navigation window" ⇒ [Parameter] ⇒ [FX5UJCPU] or [FX5UCPU] ⇒ [Module Parameter] ⇒ [Ethernet Port] ⇒ [Basic Settings] ⇒ [External Device Configuration] ⇒ <Detailed Setting> of "External Device Configuration" is double-clicked

### Window

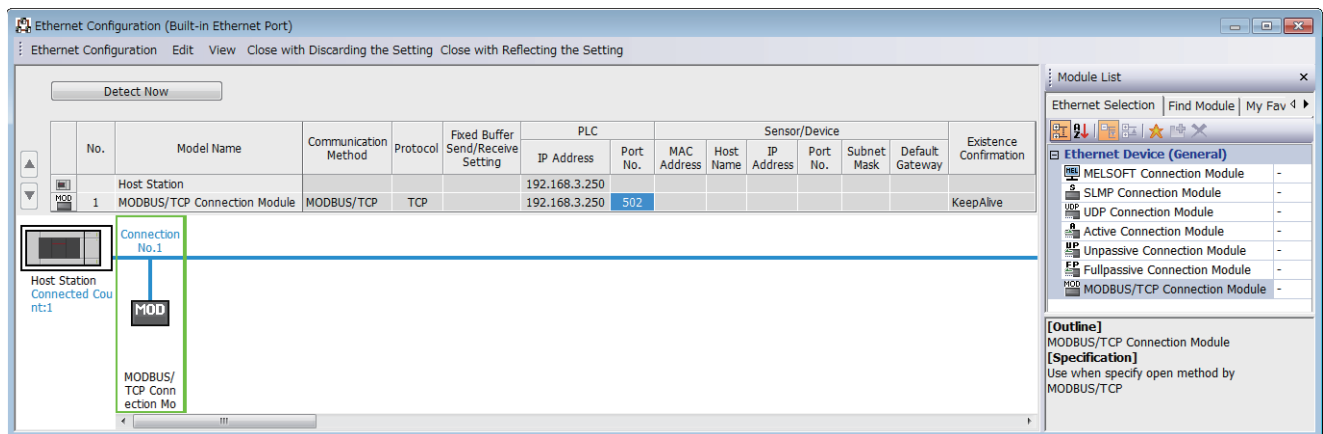

"Drag and drop the "MODBUS/TCP Connection Module" from "Module List" to the left side on the window. Execute the settings as described below.

Item	Setting	Remarks
PLC	Port No. 1 to 5548, 5570 to 65534 (Default value: 502) Do not specify 5549 to 5569 because these ports are reserved by the system.	Set the port No. of slave station.

For setup method for IP address of slave station, refer to MELSEC iQ-F FX5 User's Manual (Ethernet Communication).

### Precautions

For host station port number, using 502 is recommended. When changing the port number, use 1024 to 5548 and 5570 to 61439 (0400H to 15ACH and 15C2H to EFFFH).

When using the following functions, do not specify the port No. of the function to be used in MODBUS/TCP communication function.

- File transfer function (FTP server): 20 (14H), 21 (15H)
- Web server function: 80 (50H)\*1
- Time setting function (SNTP client): 123 (7BH)
- SLMP function: 61440 (F000H), 61441 (F001H)
- CC-Link IE field network Basic: 61450 (F00AH)

\*1 Port No. can be changed. (Default: 80)

## 12.2 Setup Method for MODBUS/TCP Communication

For the MODBUS/TCP communication setting of the FX5, set parameters with GX Works3.

"Navigation window" ⇒ [Parameter] ⇒ [FX5UJCPU] or [FX5UCPU] ⇒ [Module Parameter] ⇒ [Ethernet Port] ⇒ [Basic Settings] ⇒ [MODBUS/TCP Settings]

## Window

Item	Setting
<b>MODBUS/TCP Settings</b>	
To Use or Not to Use MODBUS/TCP Setting	Used
Device Assignment	<Detailed Setting>

Item	Setting	Remarks
To Use or Not to Use MODBUS/TCP Setting	Used/Not Used	Display the status in External Device Configuration whether MODBUS/TCP connection device is used or not used. (☞ Page 52 Setup Method for Port No.)
Device Assignment	☞ Page 53	When To Use or Not to Use MODBUS/TCP Setting is "Used", Device Assignment can be set.

## Contents of parameter setting

The device allocation used for parameter setting of MODBUS/TCP communication are as follows.

### MODBUS device allocation

In the MODBUS device allocation, initial values are set for parameters. (Refer to ☞ Page 75 FX5 dedicated pattern)  
Parameter contents can be changed from the following screen of GX Works3.

☞ "Navigation window" ⇒ [Parameter] ⇒ [FX5UJCPU] or [FX5UCPU] ⇒ [Module Parameter] ⇒ [Ethernet Port] ⇒ [Basic Settings] ⇒ [MODBUS/TCP Settings] ⇒ <Detailed Setting> of "Device Assignment" is double-clicked

## Window

Item	Coil	Input	Input Registers	Holding Registers
<b>MODBUS Device Allocation Parameter</b> Set the parameter so that the MODBUS device can be related to the device memory of PLC CPU as a slave.				
Allocation 1				
Device	Y0	X0		D0
Start MODBUS Device No.	0	0	0	0
Allocation Points	1024	1024	0	8000
Allocation 2				
Device	M0			SD0
Start MODBUS Device No.	8192	0	0	20480
Allocation Points	7680	0	0	10000
Allocation 3				
Device	SM0			W0
Start MODBUS Device No.	20480	0	0	30720
Allocation Points	2048	0	0	512
Allocation 4				
Device	L0			SW0
Start MODBUS Device No.	22528	0	0	40960
Allocation Points	7680	0	0	512
Allocation 5				
Device	B0			TN0
Start MODBUS Device No.	30720	0	0	53248
Allocation Points	256	0	0	512
Allocation 6				
Device	F0			STN0
Start MODBUS Device No.	38912	0	0	57344
Allocation Points	128	0	0	16

Set the parameter so that the MODBUS device can be related to the device memory of PLC CPU as a slave.

Buttons: Check, Restore the Default Settings, Set to FX3 Compatible Value, OK, Cancel

Setting item	Description
Allocation 1 to 16	Allocation of each MODBUS device can be set to 1 to 16.
Device	Set the device type and head number of the device to be allocated.(For available devices, refer to ☞ Page 54 Available devices)
Start MODBUS Device No.	Set the start MODBUS device number.
Allocation Points	Set the number of allocation points.

## Available devices

The following table shows devices that can be set to coil, input, input register, and holding register.

List of devices		Allocable MODBUS device				
Device type	Device	Coil	Input	Input register	Holding register	
Special relay	SM	○	○	○*1	○*1	
Special register	SD	—	—	○	○	
Input	X	○	○	○*1	○*1	
Output	Y	○	○	○*1	○*1	
Internal relay	M	○	○	○*1	○*1	
Latch relay	L	○	○	○*1	○*1	
Annunciator	F	○	○	○*1	○*1	
Link relay	B	○	○	○*1	○*1	
Data register	D	—	—	○	○	
Link register	W	—	—	○	○	
Timer	Coil	TC	○	○	○*1	○*1
	Contact	TS	○	○	○*1	○*1
	Current value	TN	—	—	○	○
Retentive timer	Coil	STC	○	○	○*1	○*1
	Contact	STS	○	○	○*1	○*1
	Current value	STN	—	—	○	○
Counter	Coil	CC	○	○	○*1	○*1
	Contact	CS	○	○	○*1	○*1
	Current value	CN	—	—	○	○
Long counter	Coil	LCC	○	○	○*1	○*1
	Contact	LCS	○	○	○*1	○*1
	Current value	LCN	—	—	○*2	○*2
Link special relay	SB	○	○	○*1	○*1	
Link special register	SW	—	—	○	○	
Step relay	S	○	○	○*1	○*1	
Index register	Z	—	—	○	○	
Index register	LZ	—	—	○*2	○*2	
File register	R	—	—	○	○	
Extended file register	ER	—	—	—	—	

\*1 Set the device number and the allocating points in multiples of 16. In the case that the number of points is not a multiple of 16, a parameter setting error occurs in GX Works3.

\*2 Because MODBUS devices are long type devices, 2 points are allocated.

## Precautions

- The same device cannot be set for a coil and an input.
- The same device cannot be set for an input register and a holding register.
- A parameter setting error occurs in GX Works3 when the total of selected head device number and the allocated points exceed the valid range for the selected PLC device.



# 13 FUNCTION

This chapter explains the function of MODBUS/TCP communication.

## 13.1 Master Function

The master station of FX5 executes communication between the master station and the slave station by using the predefined protocol support function. The CPU module executing the predefined protocol support function will be the master station. The communication setup method and procedure for program of MODBUS/TCP communication (master) are shown below. For details of each operations and applied instructions, refer to MELSEC iQ-F FX5 User's Manual (Ethernet Communication).

### Connection settings

"Navigation window" ⇒ [Parameter] ⇒ [FX5UJCPU] or [FX5UCPU] ⇒ [Module Parameter] ⇒ [Ethernet Port] ⇒ [Basic Settings] ⇒ [External Device Configuration] ⇒ double click <Detailed Setting> of "External Device Configuration"

13

### Window

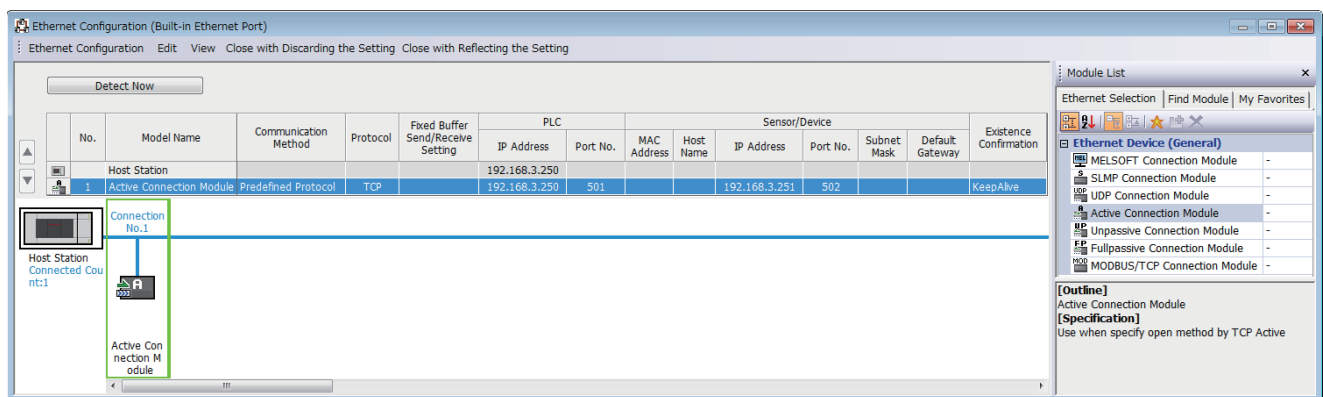

"Drag and drop the "Active Connection Module" from "Module List" to the left side on the window. Execute the settings as described below.

Item	Setting	Remarks
Communication Method	Specify the Predefined Protocol.	—
PLC	Port No. 1 to 5548, 5570 to 65534 Do not specify 5549 to 5569 because these ports are used by the system.	Set the port No. of master station.
Sensor/Device	IP Address	0.0.0.1 to 223.255.255.254
	Port No.	—

## Protocol settings

Send the request message from the master station to the slave station through the predefined protocol support function.  
Create the protocol data of MODBUS function requesting to the slave station.

[Tool] ⇒ [Predefined Protocol Support Function] ⇒ [File] ⇒ [New] ⇒ "Protocol Setting" screen ⇒ [Edit] ⇒ [Add Protocol]

Set the following items, and add the protocol of MODBUS/TCP communication.

Item	Description
Type	Specify the Predefined Protocol Library.
Manufacturer	Specify the General-purpose protocol.
Model	Specify MODBUS/TCP.
Protocol Name* <sup>1</sup>	01: RD Coils (01H: Read coils)
	02: RD Discrete Inputs (02H: Read inputs)
	03: RD Holding Registers (03H: Read holding registers)
	04: RD IN Registers (04H: Read input registers)
	05: WR Single Coil (05H: Write single coil)
	06: WR Single Registers (06H: Write single register)
	15: WR Multi Coil (0FH: Write multiple coils)
	16: WR Multi Registers (10H: Write multiple registers)
	20: RD File Record (14H: Read file record)* <sup>2</sup>
	21: WR File Record (15H: Write file record)* <sup>2</sup>
	22: Mask WR Registers (16H: Mask Write register)
	23: RD/WR Multi Registers (17H: Read/write multiple registers)

\*1 ( ) is the MODBUS standard function compatible with each protocol name.

\*2 Support only the master station.

Set the packet setting to the added protocol according to the description of MODBUS device read/write.

### Point

When setting the packet setting to the FX5 slave station, use the device assigned MODBUS device for the device specified to variable. (☞ Page 53 MODBUS device allocation)

## Program

The flow of the program performing the MODBUS/TCP communication by the FX5 master station is shown below.

### 1. Establishes a connection

Open a connection of the slave station for communication by SP.SOCOPEN instruction.

### 2. Executes the protocols

Execute the protocol (MODBUS standard function) set to the slave station for communication by SPECPRTCL instruction.

### 3. Closes a connection

Close a connection of the slave station for communication by SP.SOCCLOSE instruction.

## 13.2 Slave Function

The functions of slave station of FX5 are the followings.

### Automatic response

This function performs operations according to the supported function code by communicating with the master station.

For the supported function codes, refer to  Page 50 List of supported MODBUS standard functions.

### MODBUS device allocation

This function automatically converts access of the slave station to MODBUS device into access to the CPU module.

MODBUS device is allocated to the device set in the communication setting.

For details of MODBUS device allocation, refer to  Page 53 MODBUS device allocation.

### Ethernet diagnostics

This function can execute the troubleshooting when an abnormality occurs.

For details of ethernet diagnostics, refer to  MELSEC iQ-F FX5 User's Manual (Ethernet Communication).

## 13.3 Related Devices

In this section, the functions of the special registers are described for MODBUS/TCP communication.

The table shows the special registers used for the FX5 MODBUS/TCP communication.

Device number	Name	Valid	Details	R/W
SD10130 to SD10137	Error code	Master/ Slave	Error code(connection 1 to connection 8) of built-in Ethernet is stored.	R

R: Read

### Details of Related Devices

The following devices are used in MODBUS/TCP communication.

#### Error code

Stores the current error code of built-in Ethernet. (☞ Page 60 Error code)

Device number	Name	Description	R/W
SD10130	Error code (Connection No.1)	Stores the current error code generated during built-in Ethernet.	R
SD10131	Error code (Connection No.2)		
SD10132	Error code (Connection No.3)		
SD10133	Error code (Connection No.4)		
SD10134	Error code (Connection No.5)		
SD10135	Error code (Connection No.6)		
SD10136	Error code (Connection No.7)		
SD10137	Error code (Connection No.8)		

R: Read

#### Precautions

Do not change the device value using a program or an engineering tool.

# APPENDIX

## Appendix 1 Troubleshooting

### MODBUS serial communication

When an error occurs with MODBUS serial communication, check the following items.

#### Checking the communication status based on LED indication

Check the status of the "RD" and "SD" indicator LEDs provided.

LED status		Operation status
RD	SD	
Lit	Lit	Data is being sent and received.
Lit	Unlit	Data is received, but is not sent.
Unlit	Lit	Data is sent, but is not received.
Unlit	Unlit	Data is neither sent nor received.

While MODBUS serial communication is functioning normally, both LEDs are lit.

If they are not lit, check the wiring, communication settings, and error statuses of the master and slave stations.

#### Checking the installation and wiring

##### ■Mounting status

Verify that the communication equipment is securely connected with the CPU module, the expansion board or the expansion adapter. If the communication equipment is not securely connected, communication will not function correctly.

For the mounting procedure, refer to the respective communication equipment manual.

##### ■Wiring

Verify that all communication equipment is correctly wired. If the wiring is incorrect, communication will not function correctly.

For the wiring check method, refer to  Page 22 WIRING.

#### Checking parameters

##### ■Communication setting of parameters

Verify that the communication setting parameters are suitable for use. If the communication settings are not suitable for use, communication will not function correctly. After changing any parameters, make sure to turn off the CPU module power, and then the power on again, or reset.

For the MODBUS communication settings, refer to  Page 27 COMMUNICATION SETTING.

### MODBUS/TCP communication

When an abnormality occurs in MODBUS/TCP communication, confirm the detail of abnormality with Ethernet diagnostics.

( MELSEC iQ-F FX5 User's Manual (Ethernet Communication))

# Appendix 2 Error code

## Communication error

### ■Error flags

If a communication error occurs in the serial communication, the serial communication error flag turns ON. Verify that the device specified in the table below is ON.

FX5 dedicated				FX3 series compatible		Name	Description
CH1	CH2	CH3	CH4	CH1	CH2		
SM8500	SM8510	SM8520	SM8530	SM8063	SM8438	Serial communication error	Turns ON when an error occurs in serial communication.
—				SM8402	SM8422	MODBUS communication error	Turns ON when an error occurs in MODBUS communication.
				SM8403	SM8423	MODBUS communication error (latched)	Turns on once an error occurs during MODBUS serial communication.

### ■Error codes

When the serial communication error turns ON, the error code and error detail will be stored in the relevant device.

FX5 dedicated				FX3 series compatible		Name	Description
CH1	CH2	CH3	CH4	CH1	CH2		
SD8500	SD8510	SD8520	SD8530	SD8402 SD8063	SD8422 SD8438	Serial communication error code	When a serial communication error occurs, the error code is stored.
SD8501	SD8511	SD8521	SD8531	SD8403	SD8423	Serial communication error detail	When a serial communication error occurs, the error detail is stored.

When an error occurs in Ethernet communication, the error code is stored in the device corresponding to each connection.

Device number	Name	Description
SD10130	Error code (Connection No.1)	Stores the current error code generated during built-in Ethernet.
SD10131	Error code (Connection No.2)	
SD10132	Error code (Connection No.3)	
SD10133	Error code (Connection No.4)	
SD10134	Error code (Connection No.5)	
SD10135	Error code (Connection No.6)	
SD10136	Error code (Connection No.7)	
SD10137	Error code (Connection No.8)	

The error codes (hexadecimal) and error details stored in devices are shown as follows.

Error code	Error details	Error name and Description	MODBUS communication		Error station
			Serial	TCP	
7001H	—	When used by the communication other than MODBUS communication	○	×	Slave
7010H	—	Parity, overrun (rx register) or framing error	○	×	Master/Slave
7304H	—	CRC error	○	×	Master/Slave
7305H	—	Bus character overrun The received data amount is 256 bytes or more	○	○	Master/Slave*1
7306H	—	Data length mismatch The number of bytes received does not match with the specified number of bytes	○	○	Master/Slave*1
7307H	—	Unsupported function code error	○	○	Slave
7308H	—	Invalid device address	○	○	Slave
7309H	—	Slave response timeout A slave does not respond within the time set in the time-out time setting of the communication parameter	○	×	Master

Error code	Error details	Error name and Description	MODBUS communication		Error station
			Serial	TCP	
730AH	The following "response message formats" are set. Exception function code: High-order byte Exception code: Low-order byte (Page 44 When the processing is completed in error at the slave)	Exception response error Slave answers by exception response	○	×	Master
730BH	The following "response message formats" are set. Request station number: High-order byte Response station number: Low-order byte	Slave station No. mismatch The slave station No. of the response does not match the slave station No. of the request	○	×	Master
730CH	The following "response message formats" are set. Request function code: High-order byte Response function code: Low-order byte	Function code mismatch The function code of the response does not match the function code of the request	○	×	Master
730DH	Response function code is stored.	Illegal broadcast command The read command is a broadcast command.	○	×	Slave
730EH	—	Illegal data value in request A value outside the valid range is included in a request message	○	×	Slave
7311H	—	Port No. duplication The port No. to be used and the port No. of the other function are duplicated	×	○	Slave

○: Applicable, ×: Not applicable

\*1 In MODBUS/TCP communication, an error occurs only in the slave station.

### ■When the processing is completed in error at the slave

When a master receives an exception response from a slave, the following "response message formats" are set.

b15 to b8 b7 to b0

Exception function code (high-order byte)	Exception code (low-order byte)
--	------------------------------------

The following table outlines the exception function codes (high-order byte).

Exception function code	Function name	Details
01H	Read coils	Completed with an error by read binary (R/W) devices
02H	Read discrete inputs	Completed with an error by read binary (RO) devices
03H	Read holding registers	Completed with an error by read 16 bit (R/W) register
04H	Read input registers	Completed with an error by read 16 bit (RO) register
05H	Write single coil	Completed with an error by write single binary device
06H	Write single register	Completed with an error by write single 16 bit register device
0FH	Write multiple coils	Completed with an error by write multiple binary (R/W) devices
10H	Write multiple registers	Completed with an error by write multiple 16 bit (R/W) registers
16H	Mask Write Register	Completed with an error by manipulate slave register with AND Mask/OR Mask
17H	Read/Write Multiple Registers	Completed with an error by read/write multiple 16 bit (R/W) registers

The following table outlines the exception codes (low-order byte).

Exception code	Exception code name	Details
01H	Illegal function code	Unsupported function code was received
02H	Illegal device address	MODBUS address to which device is not allocated was accessed
03H	Illegal data value	An error occurred in the data area of the request message



## Operation error

### ■Error flags

The operation error flag turns ON when an operation error occurs in the ADPRW instruction.

Verify that the device specified in the table below is ON.

FX5 dedicated				Name	Description
CH1	CH2	CH3	CH4		
SM0				Latest self-diagnostic error (Including the annunciator ON)	Turns ON when an operation error occurs.
SM1				Latest self-diagnostic error (Not including the annunciator ON)	
SM56, SM8067				Operation error	

### ■Error codes

When the operation error flag turns ON, the error code (hexadecimal) is stored in the operation error code (SD0/SD8067).

The error codes stored in the device are shown as follows.

Error code	Description	Details	Error station
1810H	Channel double use	Channel used by the instruction is used by another instruction.	Master/Slave
3600H	Invalid parameter setup	The instruction is used in Slave mode.	Slave
2822H	A device was specified that cannot be specified with the instruction.	Wrong operand set for the instruction.	Master
3405H	Data was entered outside of the range that can be specified.	The operand device number range or data value set for the instruction is out of range.	Master
2820H	A device or label was beyond the range that can be specified with the instruction.	The operand corresponding device set for the instruction is out of range.	Master



# Appendix 3 The frame specifications

---

## Procedure for generating of CRC

---

The error check in the MODBUS serial communication (RTU mode) is conducted by CRC (Cyclic Redundancy Check).

A procedure for generating a CRC is:

- 1.** Load the register whose 16 bits are all "1". Call this the CRC register.
- 2.** Exclusive OR the first 8 bit byte of the message with the low-order byte of the 16 bit CRC register, putting the result in the CRC register.
- 3.** Shift the CRC register one bit to the right (toward the Least Significant Bit), zero-filling the MSB (Most Significant bit).
- 4.** Check the carry flag.
  - (If the carry flag was 0): Repeat Step 3 (another shift).
  - (If the carry flag was 1): Exclusive OR the CRC register with the value A001H (1010 0000 0000 0001).
- 5.** Repeat Steps 3 and 4 until 8 shifts have been executed. When this is done, a complete 8 bit byte will have been processed.
- 6.** Repeat Steps 2 through 5 for the next 8 bit byte of the message. Continue doing this until all bytes have been processed.
- 7.** The final content of the CRC register is the CRC value.
- 8.** When the CRC is placed in the message, the upper 8 bits is put in after the lower 8 bits.

The following is a calculation example in the case where function code 05H is sent to station No. (address field) 2.

CRC error check procedure	16-bit register				Carry Flag
(Load the register whose 16 bits are all "1")	1111	1111	1111	1111	
02H (Station No.)	0000	0000	0000	0010	
Exclusive OR (XOR)	1111	1111	1111	1101	
Shift 1	0111	1111	1111	1110	1
Generator value	1010	0000	0000	0001	
Exclusive OR (XOR)	1101	1111	1111	1111	
Shift 2	0110	1111	1111	1111	1
Generator value	1010	0000	0000	0001	
Exclusive OR (XOR)	1100	1111	1111	1110	
Shift 3	0110	0111	1111	1111	0
Shift 4	0011	0011	1111	1111	1
Generator value	1010	0000	0000	0001	
Exclusive OR (XOR)	1001	0011	1111	1110	
Shift 5	0100	1001	1111	1111	0
Shift 6	0010	0100	1111	1111	1
Generator value	1010	0000	0000	0001	
Exclusive OR (XOR)	1000	0100	1111	1110	
Shift 7	0100	0010	0111	1111	0
Shift 8	0010	0001	0011	1111	1
Generator value	1010	0000	0000	0001	
Exclusive OR (XOR)	1000	0001	0011	1110	
05H (Function code)	0000	0000	0000	0101	
Exclusive OR (XOR)	1000	0001	0011	1011	
Shift 1	0100	0000	1001	1101	1
Generator value	1010	0000	0000	0001	
Exclusive OR (XOR)	1110	0000	1001	1100	
Shift 2	0111	0000	0100	1110	0
Shift 3	0011	1000	0010	0111	0
Shift 4	0001	1100	0001	0011	1
Generator value	1010	0000	0000	0001	
Exclusive OR (XOR)	1011	1100	0001	0010	
Shift 5	0101	1110	0000	1001	0
Shift 6	0010	1111	0000	0100	1
Generator value	1010	0000	0000	0001	
Exclusive OR (XOR)	1000	1111	0000	0101	
Shift 7	0100	0111	1000	0010	1
Generator value	1010	0000	0000	0001	
Exclusive OR (XOR)	1110	0111	1000	0011	
Shift 8	0111	0011	1100	0001	1
Generator value	1010	0000	0000	0001	
Exclusive OR (XOR)	1101	0011	1100	0000	
CRC value	D3H		C0H		

Address field	Function code	CRC (Error check)	
(02H)	(05H)	(C0H)	(D3H)

# MODBUS protocol data unit formats

This section explains MODBUS protocol data unit formats of the MODBUS standard functions.

The MODBUS protocol data unit contains request messages sent from the master to a slave and response messages sent from the slave to the master.

## How to see the request/response message formats

### Request/Response message format diagram

The following shows how to see the request/response message format diagrams provided in [Page 66 Read coils to](#) [Page 74 Read/Write multiple registers](#).

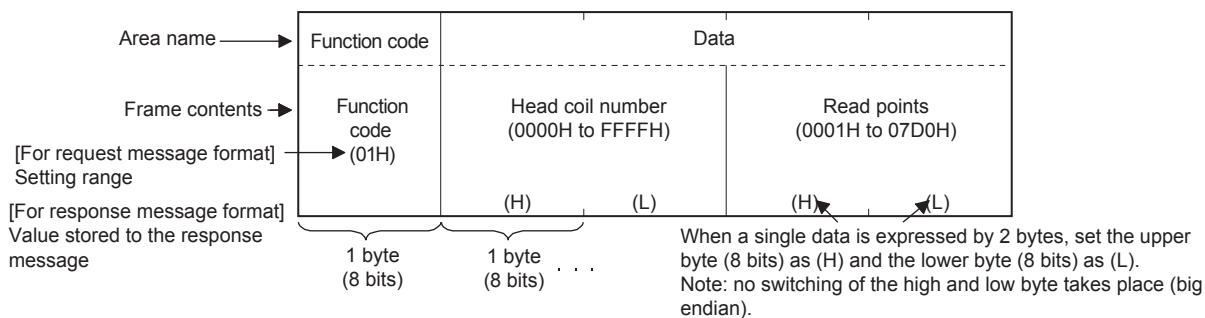

### Response message format

The response message formats issued from the slave to the master differs depending on whether the slave has normally completed or failed to handle the requested processing (read/write, diagnosis etc.).

The formats for normal and error completions are shown in [Page 66 Read coils to](#) [Page 74 Read/Write multiple registers](#).

## Precautions

### When the slave receives a broadcast request message

Although the processing requested by the request message is performed, no response message is sent to the master.

### When the processing is completed with error at the slave

When the processing (read/write, diagnosis etc.) requested by the request message is completed with error, an exception code is sent to the master.

Refer to "Response message formats (when completed with an error)" in [Page 66 Read coils to](#) [Page 74 Read/Write multiple registers](#).

### Storage location of exception code and error code

Refer to the following sections for the storage location, confirmation methods, and other detailed contents.

MODBUS serial communication: [Page 35 Related Devices](#)

MODBUS/TCP communication : [Page 58 Related Devices](#)



## Read coils

Reads the status (ON/OFF) of one or more coils.

Supports the MODBUS serial communication and MODBUS/TCP communication.

### ■Request message format (Master → Slave)

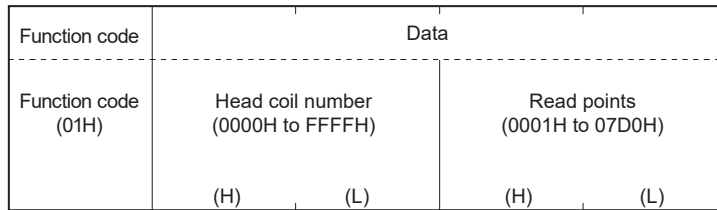

### ■Response message format (Slave → Master)

(When completed normally)

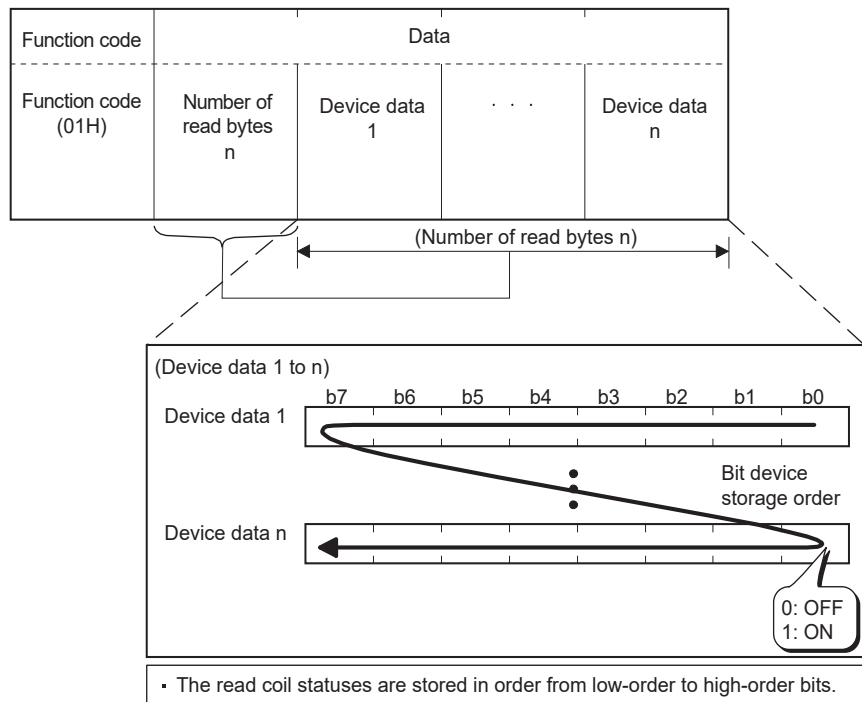

(When completed with an error)

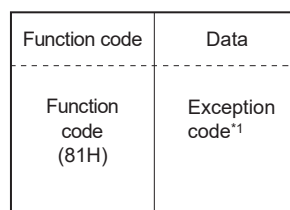

\*1 Exception and error codes are stored in special registers in the case of error completion. Refer to the following sections for the storage location, confirmation methods, and other detailed contents.

MODBUS serial communication: Page 35 Related Devices

MODBUS/TCP communication: Page 58 Related Devices

## Read inputs

Reads the status (ON/OFF) of one or more inputs.

Supports the MODBUS serial communication and MODBUS/TCP communication.

### Request message format (Master → Slave)

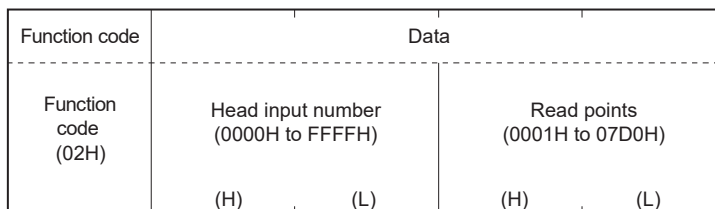

### Response message format (Slave → Master)

(When completed normally)

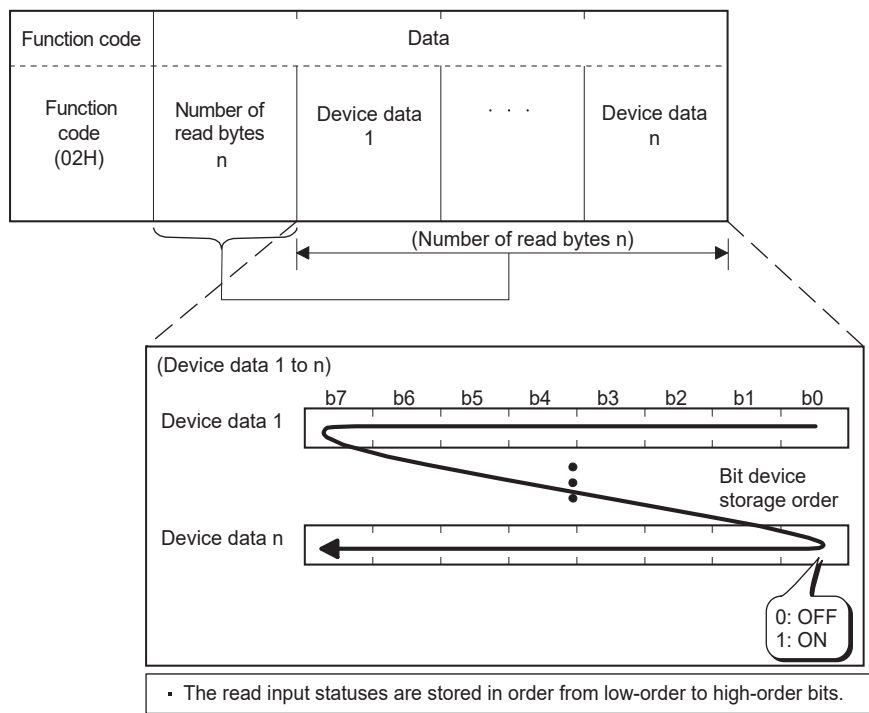

(When completed with an error)

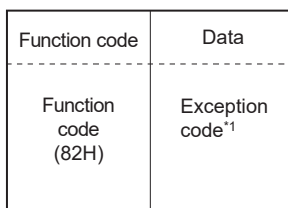

\*1 Exception and error codes are stored in special registers in the case of error completion. Refer to the following sections for the storage location, confirmation methods, and other detailed contents.

MODBUS serial communication: Page 35 Related Devices

MODBUS/TCP communication: Page 58 Related Devices



## Read holding registers

Reads the values of one or more holding registers.

Supports the MODBUS serial communication and MODBUS/TCP communication.

### Request message format (Master → Slave)

Function code	Data			
Function code (03H)	Head holding register number (0000H to FFFFH)		Read points (0001H to 007DH)	
	(H)	(L)	(H)	(L)

### Response message format (Slave → Master)

(When completed normally)

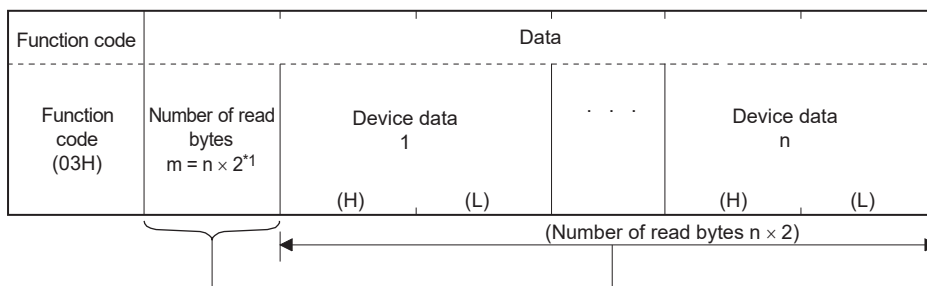

\*1 For example, if  $n = 4$ , the number of bytes is calculated as  $4 \times 2 = 8$  bytes.

(When completed with an error)

Function code	Data
Function code (83H)	Exception code <sup>*2</sup>

\*2 Exception and error codes are stored in special registers in the case of error completion. Refer to the following sections for the storage location, confirmation methods, and other detailed contents.

MODBUS serial communication: Page 35 Related Devices

MODBUS/TCP communication : Page 58 Related Devices

## Read input registers

Reads the values of one or more input registers.

Supports the MODBUS serial communication and MODBUS/TCP communication.

### Request message format (Master → Slave)

Function code	Data			
Function code (04H)	Head input register number (0000H to FFFFH)		Read points (0001H to 007DH)	
	(H)	(L)	(H)	(L)

### Response message format (Slave → Master)

(When completed normally)

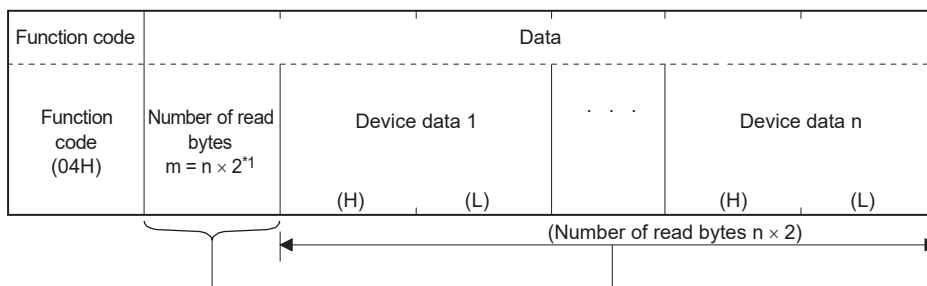

\*1 For example, if  $n = 4$ , the number of bytes is calculated as  $4 \times 2 = 8$  bytes.

(When completed with an error)

Function code	Data
Function code (84H)	Exception code <sup>*2</sup>

\*2 Exception and error codes are stored in special registers in the case of error completion. Refer to the following sections for the storage location, confirmation methods, and other detailed contents.

MODBUS serial communication: Page 35 Related Devices

MODBUS/TCP communication : Page 58 Related Devices

## Write single coil

Writes a value (ON/OFF) to one coil.

Supports the MODBUS serial communication and MODBUS/TCP communication.

### Request message format (Master → Slave)

Function code	Data	
Function code (05H)	Coil number (0000H to FFFFH)	ON/OFF specification ( 0000H: OFF FF00H: ON )
	(H) (L)	(H) (L)

### Response message format (Slave → Master)

(When completed normally)

The slave returns the request message received from the master without change.

(When completed with an error)

Function code	Data
Function code (85H)	Exception code*1

\*1 Exception and error codes are stored in special registers in the case of error completion. Refer to the following sections for the storage location, confirmation methods, and other detailed contents.

MODBUS serial communication:  Page 35 Related Devices

MODBUS/TCP communication :  Page 58 Related Devices

## Write single register

Writes a value to one holding register.

Supports the MODBUS serial communication and MODBUS/TCP communication.

### Request message format (Master → Slave)

Function code	Data	
Function code (06H)	Holding register number (0000H to FFFFH)	Write data (0000H to FFFFH)
	(H) (L)	(H) (L)

### Response message format (Slave → Master)

(When completed normally)

The slave returns the request message received from the master without change.

(When completed with an error)

Function code	Data
Function code (86H)	Exception code*1

\*1 Exception and error codes are stored in special registers in the case of error completion. Refer to the following sections for the storage location, confirmation methods, and other detailed contents.

MODBUS serial communication:  Page 35 Related Devices

MODBUS/TCP communication :  Page 58 Related Devices



## Write multiple coils

Writes values (ON/OFF) to multiple coils.

Supports the MODBUS serial communication and MODBUS/TCP communication.

### Request message format (Master → Slave)

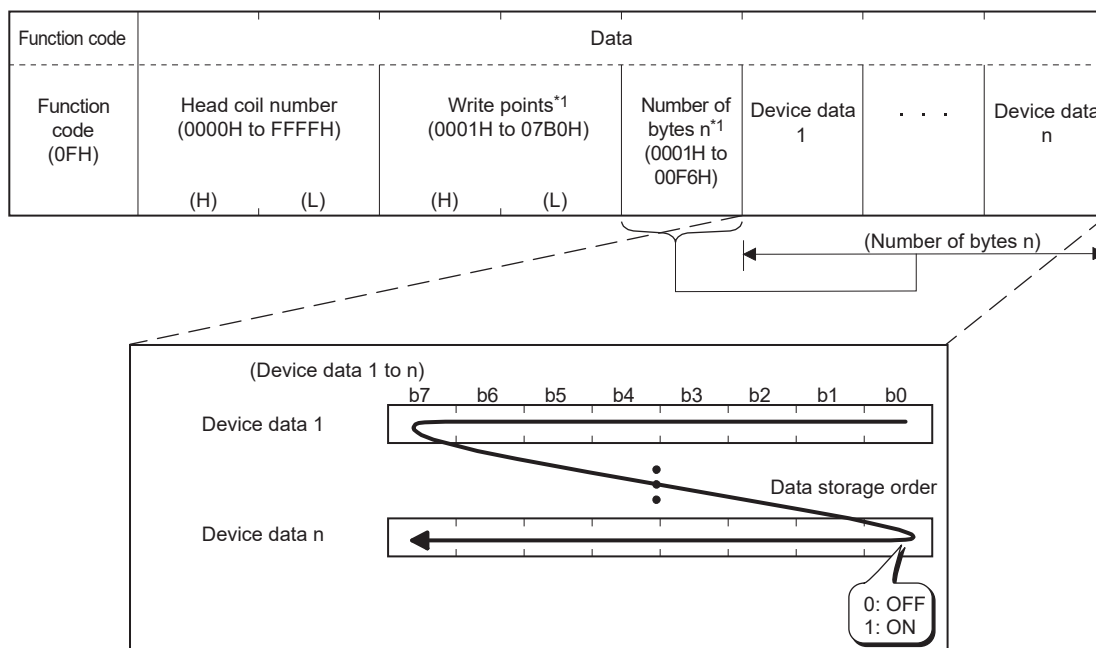

The values (ON/OFF) stored into the device data 1 to n are written to the coils in order from low-order to high-order bits of the device data.

\*<sup>1</sup> Since the number of bytes is automatically calculated, no settings are required from by ADPRW instruction and the predefined protocol support function tool.

### Response message format (Slave → Master)

(When completed normally)

Function code	Data			
Function code (0FH)	Head coil number (The same head coil number value as in the request message is stored.)		Write points (The same write points value as in the request message is stored.)	
	(H)	(L)	(H)	(L)

(When completed with an error)

Function code	Data
Function code (8FH)	Exception code* <sup>1</sup>

\*<sup>1</sup> Exception and error codes are stored in special registers in the case of error completion. Refer to the following sections for the storage location, confirmation methods, and other detailed contents.

MODBUS serial communication: Page 35 Related Devices

MODBUS/TCP communication : Page 58 Related Devices



## Write multiple registers

Writes values to multiple holding registers.

Supports the MODBUS serial communication and MODBUS/TCP communication.

### Request message format (Master → Slave)

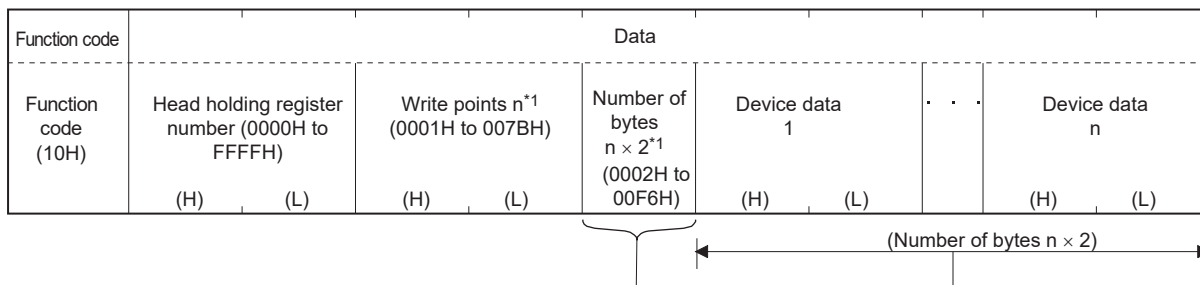

\*1 Since the number of bytes is automatically calculated, no settings are required from by ADPRW instruction and the predefined protocol support function tool.

### Response message format (Slave → Master)

(When completed normally)

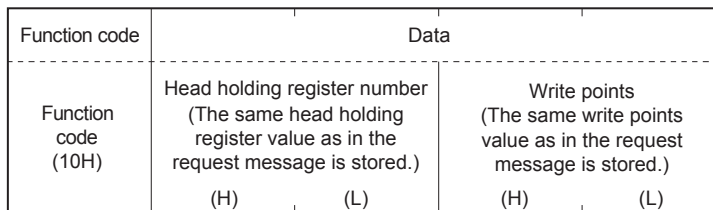

(When completed with an error)

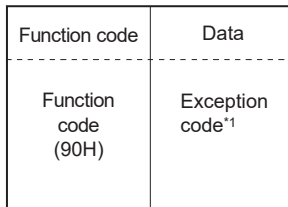

\*1 Exception and error codes are stored in special registers in the case of error completion. Refer to the following sections for the storage location, confirmation methods, and other detailed contents.

MODBUS serial communication:  Page 35 Related Devices

MODBUS/TCP communication :  Page 58 Related Devices

## Mask write register

Masks the values stored in a single holding register with AND or OR and writes the value. The masked values written to the holding register are as shown below.

- Result = (Current Contents AND And\_Mask) OR (Or\_Mask AND (NOT And\_Mask))

Support only the MODBUS/TCP communication.

### Request message format (Master → Slave)

Function code	Data					
Function code (16H)	Target holding register number (0000H to FFFFH)		AND mask value (0000H to FFFFH)		OR mask value (0000H to FFFFH)	
	(H)	(L)	(H)	(L)	(H)	(L)

### Response message format (Slave → Master)

(When completed normally)

Function code	Data
Function code (96H)	Exception code <sup>*1</sup>

\*1 Exception and error codes are stored in special registers in the case of error completion. Refer to  Page 58 Related Devices for the storage location, confirmation methods, and other detailed contents.

## Read/Write multiple registers

Reads from and writes to multiple holding registers. Writing is executed first and reading is then executed.

Support only the MODBUS/TCP communication.

### Request message format (Master → Slave)

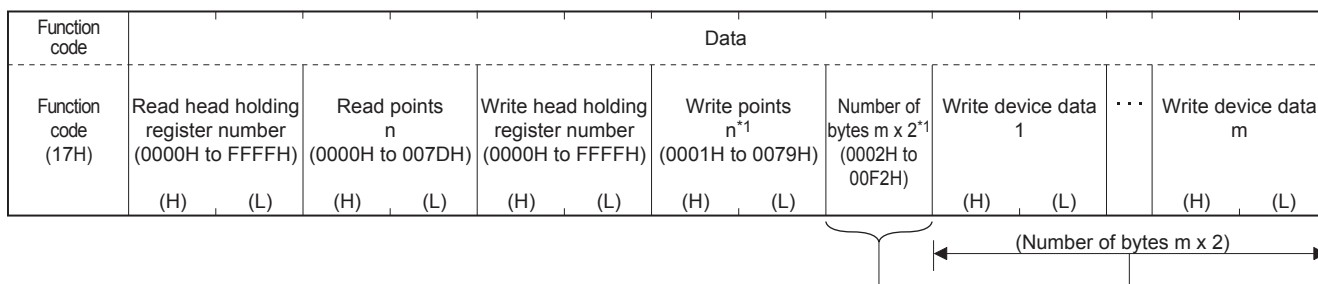

\*1 Since the number of bytes is automatically calculated, no settings are required from the predefined protocol support function tool.

### Response message format (Slave → Master)

(When completed normally)

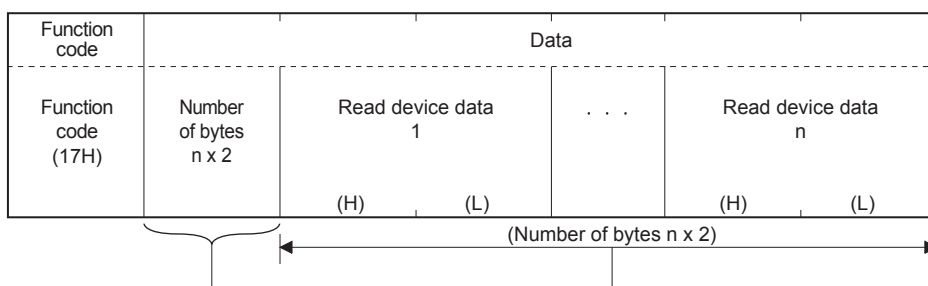

(When completed with an error)

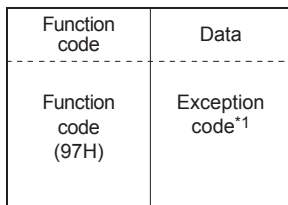

\*1 Exception and error codes are stored in special registers in the case of error completion. Refer to [Page 58 Related Devices](#) for the storage location, confirmation methods, and other detailed contents.

# Appendix 4 Initial values of MODBUS device allocation

## Parameter initial value of MODBUS device allocation

The FX5 dedicated pattern and the FX3 compatible pattern are provided for the parameter initial values.

### ■FX5 dedicated pattern

MODBUS address <Bit device>		FX5 device			
		Coil (read/write)		Input (read only)	
FX5UJ	FX5U/FX5UC	FX5UJ	FX5U/FX5UC	FX5UJ	FX5U/FX5UC
0000H to 03FFH	0000H to 03FFH	Y0 to 1023	Y0 to 1023	X0 to 1023	X0 to 1023
0400H to 1FFFH	0400H to 1FFFH	—	—	—	—
2000H to 3DFFH	2000H to 3DFFH	M0 to 7679	M0 to 7679	—	—
3E00H to 4FFFH	3E00H to 4FFFH	—	—	—	—
5000H to 57FFH	5000H to 57FFH	SM0 to 2047	SM0 to 2047	—	—
5800H to 75FFH	5800H to 75FFH	L0 to 7679	L0 to 7679	—	—
7600H to 77FFH	7600H to 77FFH	—	—	—	—
7800H to 7FFFH	7800H to 78FFFH	B0 to 2047	B0 to 255	—	—
8000H to 97FFH	7900H to 97FFH	—	—	—	—
9800H to 987FH	9800H to 987FH	F0 to 127	F0 to 127	—	—
9880H to 9FFFH	9880H to 9FFFH	—	—	—	—
A000H to A7FFH	A000H to A0FFFH	SB0 to 2047	SB0 to 255	—	—
A800H to AFFFH	A100H to AFFFH	—	—	—	—
B000H to BFFFH	B000H to BFFFH	S0 to 4095	S0 to 4095	—	—
C000H to CFFFH	C000H to CFFFH	—	—	—	—
D000H to D1FFH	D000H to D1FFH	TC0 to 511	TC0 to 511	—	—
D200H to D7FFH	D200H to D7FFH	—	—	—	—
D800H to D9FFH	D800H to D9FFH	TS0 to 511	TS0 to 511	—	—
DA00H to DFFFH	DA00H to DFFFH	—	—	—	—
E000H to E00FH	E000H to E00FH	STC0 to 15	STC0 to 15	—	—
E010H to E7FFH	E010H to E7FFH	—	—	—	—
E800H to E80FH	E800H to E80FH	STS0 to 15	STS0 to 15	—	—
E810H to EFFFH	E810H to EFFFH	—	—	—	—
F000H to F0FFH	F000H to F0FFH	CC0 to 255	CC0 to 255	—	—
F100H to F7FFH	F100H to F7FFH	—	—	—	—
F800H to F8FFH	F800H to F8FFH	CS0 to 255	CS0 to 255	—	—
F900H to FFFFH	F900H to FFFFH	—	—	—	—

MODBUS address <Word device>		FX5 device			
		Input register (read only)		Holding register (read/write)	
FX5UJ	FX5U/FX5UC	FX5UJ	FX5U/FX5UC	FX5UJ	FX5U/FX5UC
0000H to 1F3FH	0000H to 1F3FH	—	—	D0 to 7999	D0 to 7999
1F40H to 4FFFH	1F40H to 4FFFH	—	—	—	—
5000H to 770FH	5000H to 770FH	—	—	SD0 to 9999	SD0 to 9999
7710H to 77FFH	7710H to 77FFH	—	—	—	—
7800H to 7BFFH	7800H to 79FFH	—	—	W0 to 1023	W0 to 511
7C00H to 9FFFH	7A00H to 9FFFH	—	—	—	—
A000H to A3FFH	A000H to A0FFFH	—	—	SW0 to 1023	SW0 to 511
A400H to CFFFH	A100H to CFFFH	—	—	—	—
D000H to D1FFH	D000H to D1FFH	—	—	TN0 to 511	TN0 to 511
D200H to DFFFH	D200H to DFFFH	—	—	—	—
E000H to E00FH	E000H to E00FH	—	—	STN0 to 15	STN0 to 15
E010H to EFFFH	E010H to EFFFH	—	—	—	—

A

MODBUS address <Word device>		FX5 device			
		Input register (read only)		Holding register (read/write)	
FX5UJ	FX5U/FX5UC	FX5UJ	FX5U/FX5UC	FX5UJ	FX5U/FX5UC
F000H to F0FFH	F000H to F0FFH	—	—	CN0 to 255	CN0 to 255
F100H to FFFFH	F100H to FFFFH	—	—	—	—

### ■FX3 compatible pattern

MODBUS address <Bit device>		FX5 device	
		Coil (read/write)	Input (read only)
0000H to 1DFFH		M0 to 7679	—
1E00H to 1FFFH		SM8000 to 8511	—
2000H to 2FFFH		S0 to 4095	—
3000H to 31FFH		TS0 to 511	—
3200H to 32FFH		CS0 to 255	—
3300H to 33FFH		Y0 to 377	—
3400H to 34FFH		—	X0 to 377
3500H to FFFFH		—	—

MODBUS address <Word device>		FX5 device	
		Input register (read only)	Holding register (read/write)
0000H to 1F3FH		—	D0 to 7999
1F40H to 213FH		—	SD8000 to 8511
2140H to A13FH		—	R0 to 32767
A140H to A33FH		—	TN0 to 511
A340H to A407H		—	CN0 to 199
A408H to A477H		—	LCN0 to 55
A478H to A657H		—	M0 to 7679
A658H to A677H		—	SM8000 to 8511
A678H to A777H		—	S0 to 4095
A778H to A797H		—	TS0 to 511
A798H to A7A7H		—	CS0 to 255
A7A8H to A7B7H		—	Y0 to 377
A7B8H to A7BCH		X0 to 377	LCS0 to 63
A7BDH to A7C7H		—	—
A7C8H to FFFFH		—	—

# Appendix 5 Added and Enhanced Functions

The functions added or changed with the CPU module and engineering tool, and the supported CPU modules' firmware version and engineering tool software version are given below.

The firmware version can be confirmed with module diagnosis (CPU diagnosis). Refer to the following manuals for details on diagnosing the module (CPU diagnosis).

📖 MELSEC iQ-F FX5UJ User's Manual (Hardware)

📖 MELSEC iQ-F FX5U User's Manual (Hardware)

📖 MELSEC iQ-F FX5UC User's Manual (Hardware)

Refer to the 📖 GX Works3 Operating Manual for details on the software version.

## FX5UJ CPU module

Add/Change Function	Supported CPU module firmware version	Supported engineering tool software version	Reference
Support FX5UJ CPU module	From the first	"1.060N" and above	—

## FX5U/FX5UC CPU module

Add/Change Function	Supported CPU module firmware version	Supported engineering tool software version	Reference
Support MODBUS/TCP communication function	"1.060" and above	"1.040S" and above	Page 45
Slave station No. (MODBUS address number) that can be set in FX5 master station was changed from 32 to 247.	"1.060" and above	"1.040S" and above	Page 12 Page 20 Page 32

# INDEX

---

## A

---

Address field . . . . .	20
ADPRW . . . . .	32
Available devices . . . . .	30,54

## B

---

Broadcast delay . . . . .	42
---------------------------	----

## C

---

Communication error . . . . .	60
Communication execution status output device . . . . .	34
Communication format setting value . . . . .	40
Communication specifications . . . . .	16,48
CRC . . . . .	21
Current retry value . . . . .	41

## D

---

Data . . . . .	20,50
During MODBUS communication . . . . .	37

## E

---

Error check . . . . .	20
Error code . . . . .	58

## F

---

Frame mode . . . . .	21
Frame specifications . . . . .	50
Function code . . . . .	20,50
Function code and function parameters . . . . .	33

## H

---

Host station number . . . . .	41
Host station number SD latch setting valid . . . . .	39

## I

---

Instruction execution complete . . . . .	37
--	----

## L

---

Latch setting . . . . .	31
Link time . . . . .	17
List of related devices . . . . .	35
List of supported MODBUS standard functions . . . . .	21,50

## M

---

Mask write register . . . . .	73
Master function . . . . .	16,32,55
Master processing time . . . . .	18
Message length . . . . .	50
Message to message delay . . . . .	42
MODBUS communication error . . . . .	37
MODBUS communication error (latched) . . . . .	38

MODBUS protocol data unit formats . . . . .	65
Module ID . . . . .	50

## N

---

Number of connectable units . . . . .	16
---------------------------------------	----

## O

---

Operation error . . . . .	62
Operation mode display . . . . .	41

## P

---

Parameter initial value . . . . .	75
Procedure for operation . . . . .	13,47
Protocol ID . . . . .	50

## R

---

Read coils . . . . .	66
Read holding registers . . . . .	68
Read input registers . . . . .	69
Read inputs . . . . .	67
Read/Write multiple registers . . . . .	74
Retry . . . . .	38
RS-232C . . . . .	22
RS-485 . . . . .	22

## S

---

Serial communication error . . . . .	38
Serial communication error code . . . . .	39
Serial communication error details . . . . .	40
Slave function . . . . .	16,35,48,57
Slave processing time . . . . .	18
Slave response timeout . . . . .	42
SM/SD for FX3 Series compatible . . . . .	31
System configuration . . . . .	14

## T

---

Termination . . . . .	24
Termination resistor selector switch . . . . .	24
Timeout . . . . .	39
Timeout retry count . . . . .	42
Transaction ID . . . . .	50

## W

---

Write multiple coils . . . . .	71
Write multiple registers . . . . .	72
Write single coil . . . . .	70
Write single register . . . . .	70



# MEMO

---

# REVISIONS

Revision date	Revision	Description
October 2014	A	First Edition
January 2015	B	■Added new models FX5UC CPU module
April 2015	C	A part of the cover design is changed.
October 2017	D	■Added models MODBUS/TCP communication function ■Added or modified parts SAFETY PRECAUTIONS, RELEVANT MANUALS, TERMS, Section 1.1, 3.1, Chapter 4, 6, Section 7.1, 7.3, Chapter 9, 10, 11, 12, 13, Appendix 1, 2, 3, 5
April 2018	E	■Added or modified parts Section 12.1, Appendix 3
October 2019	F	■Added new models FX5UJ CPU module ■Added or modified parts RELEVANT MANUALS, TERMS, Section 1.1, 2.1, 3.1, 6.1, 7.1, 7.3, 8.1, 8.2, 10.1, 12.1, 12.2, 13.1, Appendix 2, 4, 5
June 2021	G	■Added or modified parts SAFETY PRECAUTIONS, WARRANTY

This manual confers no industrial property rights or any rights of any other kind, nor does it confer any patent licenses. Mitsubishi Electric Corporation cannot be held responsible for any problems involving industrial property rights which may occur as a result of using the contents noted in this manual.

© 2014 MITSUBISHI ELECTRIC CORPORATION

# WARRANTY

Please confirm the following product warranty details before using this product.

## 1. Gratis Warranty Term and Gratis Warranty Range

If any faults or defects (hereinafter "Failure") found to be the responsibility of Mitsubishi occurs during use of the product within the gratis warranty term, the product shall be repaired at no cost via the sales representative or Mitsubishi Service Company. However, if repairs are required onsite at domestic or overseas location, expenses to send an engineer will be solely at the customer's discretion. Mitsubishi shall not be held responsible for any re-commissioning, maintenance, or testing on-site that involves replacement of the failed module.

### [Gratis Warranty Term]

The gratis warranty term of the product shall be for one year after the date of purchase or delivery to a designated place. Note that after manufacture and shipment from Mitsubishi, the maximum distribution period shall be six (6) months, and the longest gratis warranty term after manufacturing shall be eighteen (18) months. The gratis warranty term of repair parts shall not exceed the gratis warranty term before repairs.

### [Gratis Warranty Range]

- (1) The range shall be limited to normal use within the usage state, usage methods and usage environment, etc., which follow the conditions and precautions, etc., given in the instruction manual, user's manual and caution labels on the product.
- (2) Even within the gratis warranty term, repairs shall be charged for in the following cases.
  1. Failure occurring from inappropriate storage or handling, carelessness or negligence by the user. Failure caused by the user's hardware or software design.
  2. Failure caused by unapproved modifications, etc., to the product by the user.
  3. When the Mitsubishi product is assembled into a user's device, Failure that could have been avoided if functions or structures, judged as necessary in the legal safety measures the user's device is subject to or as necessary by industry standards, had been provided.
  4. Failure that could have been avoided if consumable parts (battery, backlight, fuse, etc.) designated in the instruction manual had been correctly serviced or replaced.
  5. Relay failure or output contact failure caused by usage beyond the specified life of contact (cycles).
  6. Failure caused by external irresistible forces such as fires or abnormal voltages, and failure caused by force majeure such as earthquakes, lightning, wind and water damage.
  7. Failure caused by reasons unpredictable by scientific technology standards at time of shipment from Mitsubishi.
  8. Any other failure found not to be the responsibility of Mitsubishi or that admitted not to be so by the user.

## 2. Onerous repair term after discontinuation of production

- (1) Mitsubishi shall accept onerous product repairs for seven (7) years after production of the product is discontinued.  
Discontinuation of production shall be notified with Mitsubishi Technical Bulletins, etc.
- (2) Product supply (including repair parts) is not available after production is discontinued.

## 3. Overseas service

Overseas, repairs shall be accepted by Mitsubishi's local overseas FA Center. Note that the repair conditions at each FA Center may differ.

## 4. Exclusion of loss in opportunity and secondary loss from warranty liability

Regardless of the gratis warranty term, Mitsubishi shall not be liable for compensation to:

- (1) Damages caused by any cause found not to be the responsibility of Mitsubishi.
- (2) Loss in opportunity, lost profits incurred to the user by Failures of Mitsubishi products.
- (3) Special damages and secondary damages whether foreseeable or not, compensation for accidents, and compensation for damages to products other than Mitsubishi products.
- (4) Replacement by the user, maintenance of on-site equipment, start-up test run and other tasks.

## 5. Changes in product specifications

The specifications given in the catalogs, manuals or technical documents are subject to change without prior notice.

## 6. Product application

- (1) In using the Mitsubishi MELSEC programmable controller, the usage conditions shall be that the application will not lead to a major accident even if any problem or fault should occur in the programmable controller device, and that backup and fail-safe functions are systematically provided outside of the device for any problem or fault.
- (2) The Mitsubishi programmable controller has been designed and manufactured for applications in general industries, etc. Thus, applications in which the public could be affected such as in nuclear power plants and other power plants operated by respective power companies, and applications in which a special quality assurance system is required, such as for railway companies or public service purposes shall be excluded from the programmable controller applications.  
In addition, applications in which human life or property that could be greatly affected, such as in aircraft, medical applications, incineration and fuel devices, manned transportation, equipment for recreation and amusement, and safety devices, shall also be excluded from the programmable controller range of applications. However, in certain cases, some applications may be possible, providing the user consults their local Mitsubishi representative outlining the special requirements of the project, and providing that all parties concerned agree to the special circumstances, solely at the user's discretion.
- (3) Mitsubishi shall have no responsibility or liability for any problems involving programmable controller trouble and system trouble caused by DoS attacks, unauthorized access, computer viruses, and other cyberattacks.

# TRADEMARKS

---

PROFIBUS is a trademark of PROFIBUS Nutzerorganisation e.V.

Anywire and AnyWireASLINK are either registered trademarks or trademarks of Anywire Corporation.

The company names, system names and product names mentioned in this manual are either registered trademarks or trademarks of their respective companies.

In some cases, trademark symbols such as <sup>™</sup> or <sup>®</sup> are not specified in this manual.



Manual number: JY997D56101G(2106)

MODEL: FX5-U-MB-E

MODEL CODE: 09R542

## **MITSUBISHI ELECTRIC CORPORATION**

HEAD OFFICE : TOKYO BUILDING, 2-7-3 MARUNOUCHI, CHIYODA-KU, TOKYO 100-8310, JAPAN  
NAGOYA WORKS : 1-14 , YADA-MINAMI 5-CHOME , HIGASHI-KU, NAGOYA , JAPAN

When exported from Japan, this manual does not require application to the  
Ministry of Economy, Trade and Industry for service transaction permission.

Specifications subject to change without notice.